

QUICK RELEASE COUPLINGS

QRC016



 **intertraco**



QUICK RELEASE COUPLINGS

QRC016

© Intertraco (Italia) S.p.A.

Quick Release Couplings - **GSIQRC160** - March 2016





The data reported in this catalogue are not binding.
Intertraco (Italia) S.p.A. reserves the right to change specifications without notice.

SERIES		PAGE
QUICK DISCONNECT COUPLINGS INNESTI RAPIDI		
A	ISO 7241-A	8
B	ISO 7241-B Industrial interchange	10
N	Agricultural interchange	12
P	Push-pull coupling	14
E	Large diameter coupling	18
S	Screw to connect coupling	20
J	Screw to connect coupling	24
PW	Free flow coupling	25
FLAT FACE COUPLINGS INNESTI RAPIDI A FACCE PIANE		
F	Flat face coupling	26
FA - FPM	High pressure flat face coupling	28
HP	Very high pressure flat face coupling	30
VP	Screw to connect flat face coupling	32
CORROSIVE ENVIRONMENT COUPLINGS INNESTI RAPIDI PER AMBIENTI CORROSIVI		
X	ISO 7241-B / AISI 316	34
R	AISI 316 Large diameter coupling	36
Z	Screw to connect coupling	38
Q	QPQ treated flat face coupling	40
M	AISI 316 Flat face coupling	44
SWIVEL JOINTS GIUNTI GIREVOLI		
SJ 10	Straight swivel joint	46
SJ 90	90° swivel joint	47
HYDRAULIC VALVES VALVOLE IN LINEA		
CV	In line check valve	48
VPCC	Burst hose valve	48
CVP	Burst hose cartridge valve	49
DPC	Double pilot operated check	49
VSU	Trottle valve	50
VRX	Uni-directional flow regulator	50
VRU	Uni-directional flow regulator	51
VRB	Bi-directional flow regulator	51
CHARTS AN OTHER INFORMATION		
The quick disconnect coupling range La gamma innesti		4
How to select the right series Come identificare la serie giusta		5
How to order the couplings Come ordinare gli innesti		6

The range

The following table indicates the standard series which are included in our  quick disconnect coupling range. The table offers a short guide to each series main features in terms of available sizes, materials, design and possible working conditions. For detailed information on each series, please refer to the following pages of this catalogue.

La seguente tabella mostra le varie serie di innesti rapidi standard che compongono la gamma  e sintetizza le loro caratteristiche di massima in termini di misure, materiali, design ed applicazione. Per ulteriori informazioni rimandiamo alle pagine successive dove ciascuna serie viene trattata in modo più dettagliato.

PAG	SERIE SERIE	SIZES MISURE	INTERCHANGE INTERCAMBIABILITÀ	MATERIAL MATERIALE	VALVE DESIGN TIPO DI VALVOLA	RITENTION BLOCCAGGIO	WORKING PRESS. RANGE PRESSIONE DI ESERCIZIO	TEMP. RANGE TEMP. DI ESERCIZIO	ENVIRONMENT AMBIENTE
8	A	1/4" - 2"	ISO 7241 - a	steel acciaio	poppet funghetto	ball locking sfere radiali	0 - 250 bar	-20/+110°C	est.+interno ext.+indoor
10	B	1/8" - 1"	ISO 7241 - b	steel acciaio	poppet funghetto	ball locking sfere radiali	0 - 250 bar	-20/+110°C	est.+interno ext.+indoor
12	N	1/4" - 1"	-	steel acciaio	poppet or ball funghetto o sfera	ball locking sfere radiali	0 - 250 bar	-20/+110°C	est.+interno ext.+indoor
14	P	1/2"	ISO 7241 - a	steel acciaio	poppet or ball funghetto o sfera	ball locking sfere radiali	0 - 250 bar	-20/+110°C	est.+interno ext.+indoor
18	E	1.1/4" - 3"	 design disegno	steel acciaio	poppet funghetto	ball locking sfere radiali	0 - 120 bar	-20/+110°C	est.+interno ext.+indoor
20	S	1/4" - 2.1/2"	 design disegno	steel acciaio	poppet funghetto	screw to connect a vite	0 - 400 bar	-20/+110°C	est.+interno ext.+indoor
24	J	1/4" - 3/8"	-	steel acciaio	ball sfera	screw to connect a vite	0 - 700 bar	-20/+110°C	est.+interno ext.+indoor
25	PW	3/8"	-	steel+brass acciaio+ottone	free flow passaggio libero	ball locking sfere radiali	0 - 250 bar	-15/+150°C	est.+interno ext.+indoor
26	F	1/4" - 2"	htma (3/8)	steel acciaio	flat face faccia piana	ball locking sfere radiali	0 - 250 bar	-20/+110°C	est.+interno ext.+indoor
28	FA	1/8" - 1.1/2"	htma (3/8)	steel acciaio	flat face faccia piana	ball locking sfere radiali	0 - 350 bar	-20/+110°C	est.+interno ext.+indoor
28	FPM	1/4" - 1"	htma (3/8)	steel acciaio	flat face faccia piana	ball locking sfere radiali	0 - 350 bar	-20/+100°C	est.+interno ext.+indoor
30	HP	1/4" - 1/2"	-	steel acciaio	flat face faccia piana	ball locking sfere radiali	0 - 720 bar	-20/+110°C	est.+interno ext.+indoor
32	VP	1/4" - 1.1/2"	-	steel acciaio	flat face faccia piana	screw to connect a vite	0 - 500 bar	-20/+110°C	est.+interno ext.+indoor
34	X	1/8" - 1"	ISO 7241 - b	A316 inox	poppet funghetto	ball locking sfere radiali	0 - 100 bar	-15/+180°C	corrosivo corrosive
36	R	1.1/4" - 3"	 design disegno	A316 inox	poppet funghetto	ball locking sfere radiali	0 - 40 bar	-20/+180°C	corrosivo corrosive
38	Z	1/4" - 2.1/2"	 design disegno	A316 inox	poppet funghetto	screw to connect a vite	0 - 400 bar	-15/+180°C	corr.+marino corr.+marine
40	Q	1/4" - 2"	htma (3/8)	steel+QPQ acciaio+QPQ	flat face faccia piana	ball locking sfere radiali	0 - 250 bar	-50/+300°C	corrosivo corrosive
44	M	1/4" - 1.1/2"	htma (3/8)	A316 inox	flat face faccia piana	ball locking sfere radiali	0 - 350	-15/+180°C	corr.+marino corr.+marine

* The indicated performance data are guide lines only which are referred to a whole series in its various options. The actual performance of each couplings depends on the size in question, the type of material and on the selected seal; please refer to the following pages for more detailed specifications. In case of doubts or special applications, please contact our technical office.

I dati esposti in tabella sono linee guida riferite alle singole gamme nel loro insieme. Le prestazioni effettive di ciascun innesto dipendono dalla misura in questione, dal materiale adottato e dalla guarnizione selezionata. Per informazioni più dettagliate consultare le pagine seguenti. In caso di dubbi si prega di contattare il nostro servizio tecnico-commerciale.

How to order

CODE EXAMPLE:

1 st	2 nd	3 rd	4 th	5 th	6 th
A	F	1	5	V	06

 = A series, socket, poppet valve, NPTF, viton seals, 3/8" NPTF

1 st	A	It indicates the series (see Index pag. 3)			
2 nd	F	It indicates:	F	Socket	
			M	Plug	
			C	Complete (socket + plug assembled)	
3 rd	1	It indicates:	For STANDARD VALVE couplings (poppet and ball type)	0	Free flow
				1	Poppet valve
				2	Ball valve
				3	Valve allowing the connection under pressure (type 1)
			4	Valve allowing the connection under pressure (type 2)	
			For FLAT FACE couplings	1	Standard flow version
				2	High flow version
4 th	5	It indicates the type of thread	0	BSPP (parallel)	
			1	METRIC MALE 24° light series L	
			2	METRIC MALE 24° heavy series S	
			3	METRIC MALE 24° light series L bulkhead	
			4	METRIC MALE 24° heavy series S bulkhead	
			5	NPTF	
			6	METRIC FEMALE (parallel)	
			7	UNF	
			8	BSPT (tapered)	
5 th	V	This position is expressed only in case of special seals: the standard seal of each series is indicated in the following pages.	V	Viton	
			K	Karlez	
			F	Fluorosilicone	
			E	EPDM	
			N	Nitrile	
			Neo	Neoprene	
6 th	06	It indicates the thread size			

Come ordinare

1°	2°	3°	4°	5°	6°
A	F	1	5	V	06

ESEMPIO DI CODICE: **A F 1 5 V - 06** = serie A, femmina, valvola a funghetto, filettatura NPTF, guarnizioni Viton, 3/8" NPTF

1°	A	Indica la serie a cui appartiene l'innesto considerato (vedi INDICE a pag. 3)			
2°	F	Significa:	F	Femmina	
			M	Maschio	
			C	Completo (maschio + femmina accoppiati)	
3°	1	Significa:	Per INNESTI con valvola STANDARD (a funghetto o sfera)	0	Passaggio libero
				1	Valvola a funghetto
				2	Valvola a sfera
				3	Valvola per innesto in pressione (tipo 1)
			4	Valvola per innesto in pressione (tipo 2)	
			Per innesti a FACCE PIANE	1	Versione flusso standard
				2	Versione ad alto flusso
4°	5	Indica il tipo di filettatura	0	BSPP (gas cilindrico)	
			1	MASCHIO 24° METRICO serie leggera L	
			2	MASCHIO 24° METRICO serie pesante S	
			3	MASCHIO 24° METRICO serie leggera L - passaparete	
			4	MASCHIO 24° METRICO serie pesante S - passaparete	
			5	NPTF	
			6	METRICO FEMMINA	
			7	UNF	
			8	BSPT (conico)	
5°	V	Questa posizione è indicata solo in caso di guarnizione speciale. La guarnizione standard per ogni serie è indicata nelle pagine ad esse dedicate.	V	Viton	
			K	Karlez	
			F	Fluorosilicone	
			E	Etilenpropilene	
			N	Nitrile	
			Neo	Neoprene	
6°	06	Identifica la misura della filettatura			

SOCKET FEMMINA

FEMMINA

PLUG MASCHIO

MASCHIO

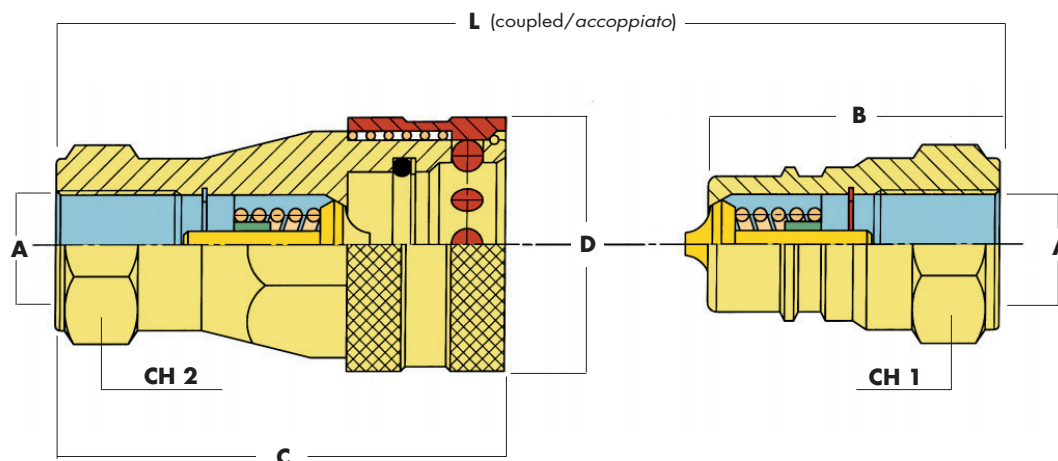

SIZE BASE	Ø DN		CODE CODICE		Ø A*	B		C		Ø D		L		CH 1		CH 2	
	mm	inch	plug maschio	socket femmina		mm	in	mm	in	mm	in	mm	in	mm	in	mm	in
04	6	1/4"	AM10-04	AF10-04	1/4"BSP	35	1.38	47	1.85	25	0.98	71	2.80	19	0.75	19	0.75
			AM15-04	AF15-04	1/4"NPTF												
			AM18-04	AF18-04	1/4"BSPT												
06	10	3/8"	AM10-06	AF10-06	3/8"BSP	39	1.54	58	2.28	31	1.22	79.5	3.13	22	0.87	24	0.94
			AM15-06	AF15-06	3/8"NPTF												
			AM18-06	AF18-06	3/8"BSPT												
08	12	1/2"	AM10-08	AF10-08	1/2"BSP	46	1.81	67.5	2.66	38	1.50	92	3.62	27	1.06	30	1.18
			AM15-08	AF15-08	1/2"NPTF												
			AM18-08	AF18-08	1/2"BSPT												
12	20	3/4"	AM10-12	AF10-12	3/4"BSP	54	2.13	81	3.19	46	1.81	108	4.25	34	1.34	38	1.50
			AM15-12	AF15-12	3/4"NPTF												
			AM18-12	AF18-12	3/4"BSPT												
16	25	1"	AM10-16	AF10-16	1"BSP	62	2.44	96	3.78	55	2.17	124	4.88	41	1.61	45	1.77
			AM15-16	AF15-16	1"NPTF												
			AM18-16	AF18-16	1"BSPT												
20	32	1.1/4"	AM10-20	AF10-20	1.1/4"BSP	75	2.95	117	4.61	65	2.56	151	5.94	55	2.17	50	1.97
			AM15-20	AF15-20	1.1/4"NPTF												
			AM18-20	AF18-20	1.1/4"BSPT												
24	38	1.1/2"	AM10-24	AF10-24	1.1/2"BSP	85	3.35	135	5.31	80	3.15	171	6.73	60	2.36	60	2.36
			AM15-24	AF15-24	1.1/2"NPTF												
			AM18-24	AF18-24	1.1/2"BSPT												
32	50	2"	AM10-32	AF10-32	2"BSP	100	3.94	160	6.30	100	3.94	201	7.91	75	2.95	75	2.95
			AM15-32	AF15-32	2"NPTF												
			AM18-32	AF18-32	2"BSPT												

* Other threads available on request Ulteriori filettature disponibili a richiesta.

MAIN DATA

Series A is designed to interchange and perform according to ISO 7241-A standard. It is one of the most popular coupling design worldwide and is indicated for several mobile and industrial applications.

- Interchangeability according to ISO 7241-A;
- Standard material: steel;
- Plugs treated with induction hardening;
- Internal valves in hardened steel;
- Standard seals in nitril rubber;
- Back-up seals in teflon;
- Working temperature with standard nitril seals: -20°C / +110°C;
- Special seals on request: Viton, EPDM, Neoprene;
- 1/2" plug and socket are also available in a special version allowing their connection in presence of residual back pressure.

CARATTERISTICHE PRINCIPALI

La serie A ha intercambiabilità e prestazioni secondo la normativa ISO 7241-A.

Si tratta di uno tra i più diffusi tipi di innesto rapido a livello internazionale e trova applicazione su un'ampia gamma di attrezzature mobili e industriali.

- Intercambiabilità secondo ISO 7241-A
- Materiale standard: acciaio;
- Parte maschio in acciaio temprato ad induzione;
- Valvole interne in acciaio temprato;
- Guarnizioni standard in gomma nitrilica;
- Anelli antiestrusione in teflon;
- Temperature esercizio con guarnizioni standard: -20°C / +110°C;
- Guarnizioni speciali a richiesta: Viton, EPDM, Neoprene;
- Gli innesti maschio e femmina da 1/2" sono disponibili anche in una versione speciale che permette il loro aggancio in presenza di pressioni residue.

PRESSURE DROP GRAPH GRAFICO PERDITE DI CARICO

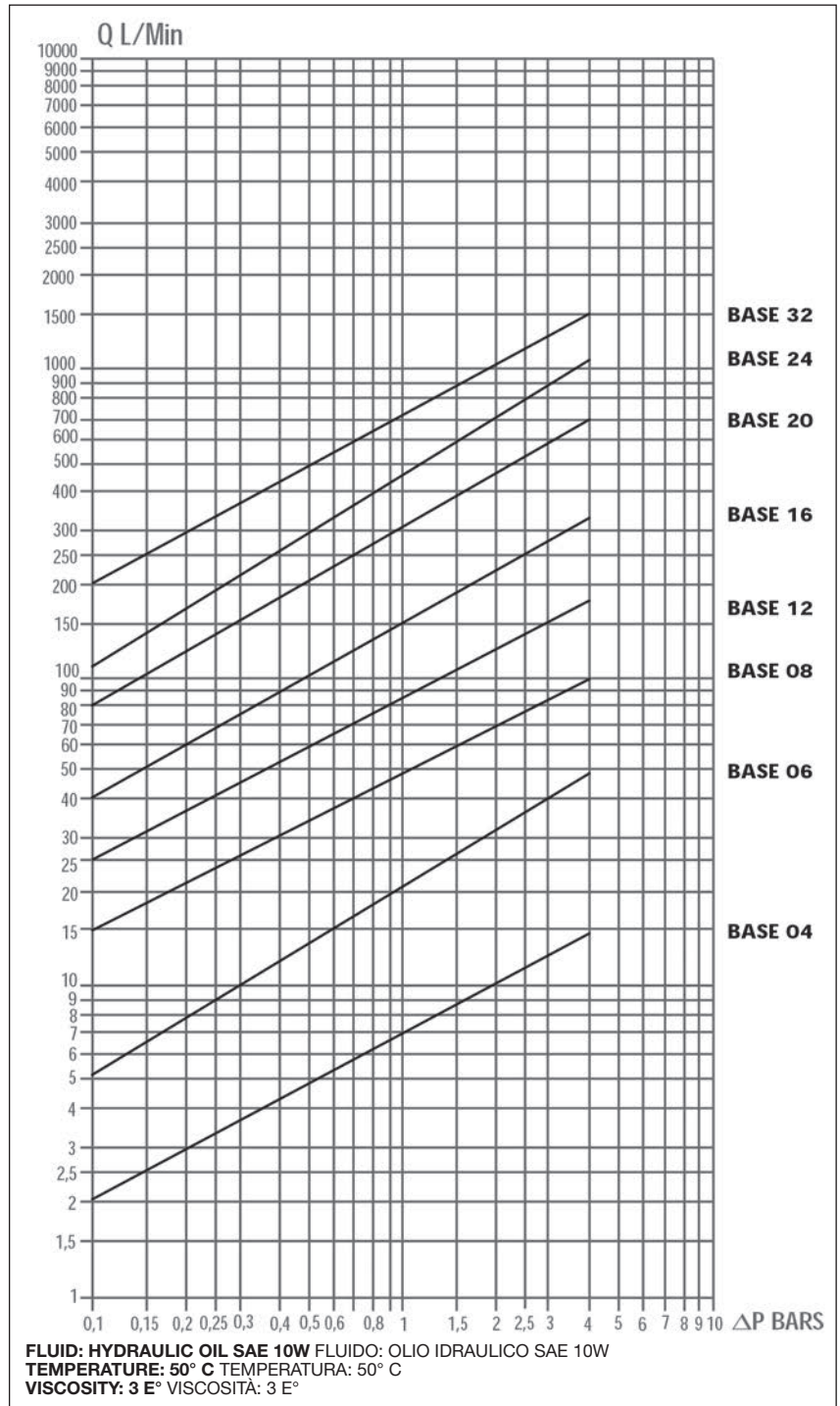

PERFORMANCES PRESTAZIONI

SIZE BASE	Ø DN		MAX WORK PRESSURE MAX PRESS. ESERCIZIO		BURST PRESSURE PRESSIONE SCOPPIO		WEIGHT PESO			
							plug maschio		socket femmina	
	mm	inch	bar	psi	bar	psi	kg	lbs	kg	lbs
04	6	1/4"	350	5075	1400	20300	0.045	0.100	0.080	0.18
06	10	3/8"	315	4567	1260	18270	0.055	0.122	0.150	0.33
08	12	1/2"	250	3625	1000	14500	0.090	0.200	0.270	0.60
12	20	3/4"	250	3625	1000	14500	0.185	0.410	0.465	1.03
16	25	1"	230	3335	920	13340	0.270	0.600	0.720	1.60
20	32	1.1/4"	230	3335	920	13340	0.600	1.330	1.250	2.78
24	38	1.1/2"	190	2755	760	11020	0.900	2.000	2.100	4.67
32	50	2"	130	1885	520	7540	1.450	3.220	4.150	9.22

SOCKET FEMMINA

PLUG MASCHIO

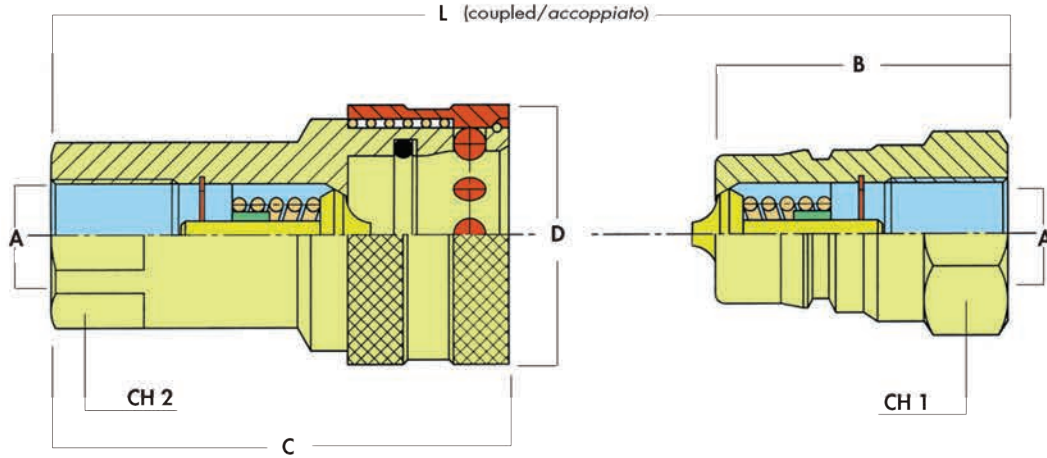

SIZE BASE	Ø DN		CODE CODICE		Ø A*	B		C		Ø D		L		CH 1		CH 2	
	mm	inch	plug maschio	socket femmina		mm	in	mm	in	mm	in	mm	in	mm	in	mm	in
02	3	1/8"	BM10-02	BF10-02	1/8"BSP	30	1.18	49	1.93	24	0.94	60.5	2.38	14	0.55	14	0.55
			BM15-02	BF15-02	1/8"NPTF												
04	6	1/4"	BM10-04	BF10-04	1/4"BSP	35	1.38	57	2.24	27	1.06	70.5	2.78	19	0.75	19	0.75
			BM15-04	BF15-04	1/4"NPTF												
06	10	3/8"	BM10-06	BF10-06	3/8"BSP	41	1.61	66	2.60	34	1.34	82.5	3.25	24	0.94	24	0.94
			BM15-06	BF15-06	3/8"NPTF												
08	12	1/2"	BM10-08	BF10-08	1/2"BSP	46	1.81	74	2.91	42	1.65	92.5	3.64	27	1.06	27	1.06
			BM15-08	BF15-08	1/2"NPTF												
12	20	3/4"	BM10-12	BF10-12	3/4"BSP	55	2.17	90	3.54	50	1.97	111	4.37	36	1.42	36	1.42
			BM15-12	BF15-12	3/4"NPTF												
16	25	1"	BM10-16	BF10-16	1"BSP	66	2.60	106	4.17	60	2.36	133	5.24	41	1.61	41	1.61
			BM15-16	BF15-16	1"NPTF												

* Other threads available on request Ulteriori filettature disponibili a richiesta.

MAIN DATA

Series B is designed to interchange and perform according to ISO 7241-B standard. It is one of the most popular coupling design worldwide and is indicated for several industrial applications.

- Interchangeability according to ISO 7241-B;
- Standard material: steel;
- Plugs treated with induction hardening;
- Internal valves in hardened steel;
- Standard seals in nitril rubber;
- Back-up seals in teflon;
- Working temperature with standard nitril seals: -20°C / +110°C;
- Special seals on request: Viton, EPDM, Neoprene;

CARATTERISTICHE PRINCIPALI

La serie B ha intercambiabilità e prestazioni secondo la normativa ISO 7241-A.

Si tratta di uno tra i più diffusi tipi di innesto rapido a livello internazionale e trova applicazione su un'ampia gamma di attrezzature industriali.

- Intercambiabilità secondo ISO 7241-B
- Materiale standard: acciaio;
- Parte maschio in acciaio temprato ad induzione;
- Valvole interne in acciaio temprato;
- Guarnizioni standard in gomma nitrilica;
- Anelli antiestrusione in teflon;
- Temperature esercizio con guarnizioni standard: -20°C / +110°C;
- Guarnizioni speciali a richiesta: Viton, EPDM, Neoprene;

PRESSURE DROP GRAPH GRAFICO PERDITE DI CARICO *

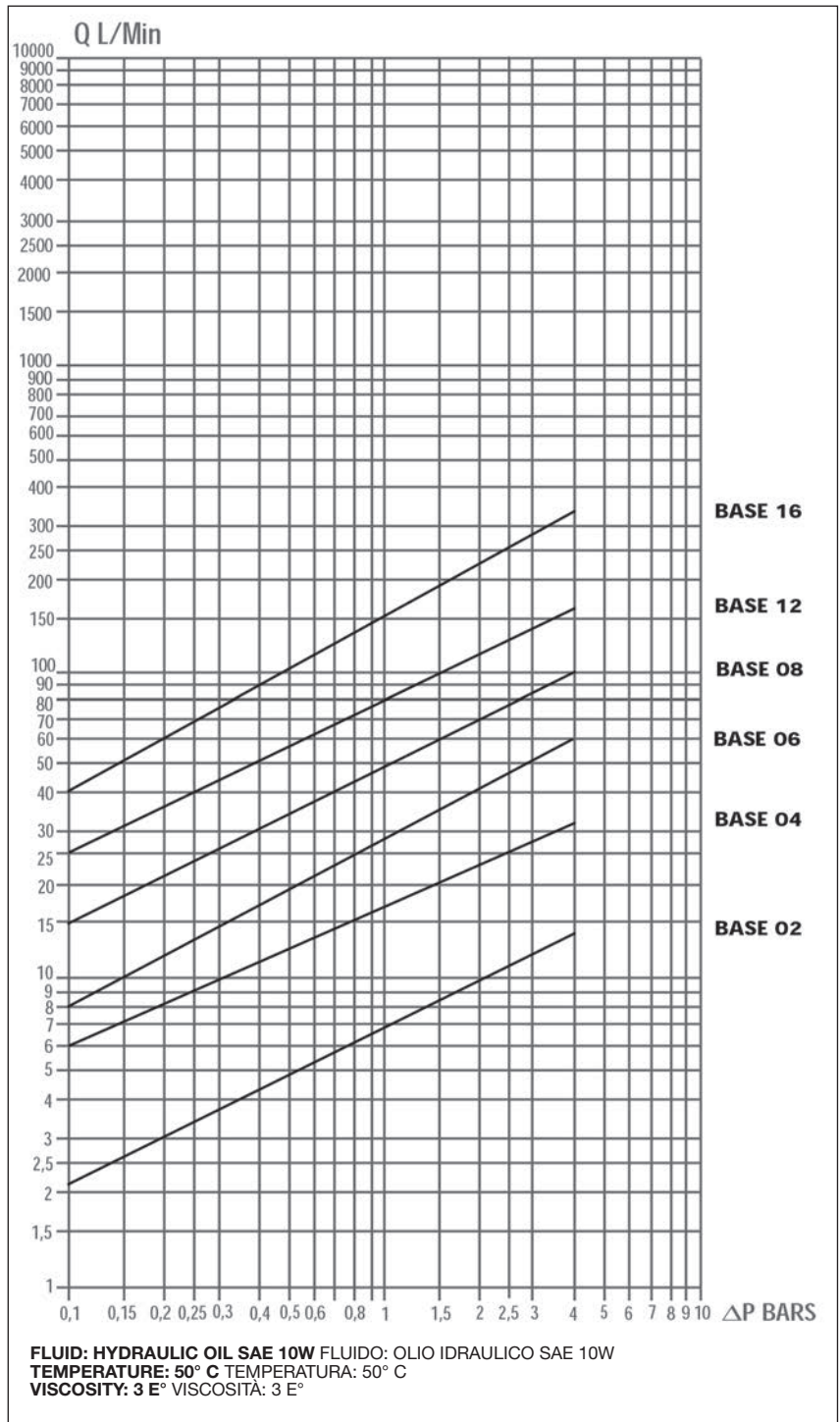

PERFORMANCES PRESTAZIONI

SIZE BASE	Ø DN		MAX WORK PRESSURE MAX PRESS. ESERCIZIO		BURST PRESSURE PRESSIONE SCOPPIO		WEIGHT PESO			
	mm	inch	bar	psi	bar	psi	plug maschio		socket femmina	
							kg	lbs	kg	lbs
02	5	1/8"	350	5075	1400	20300	0.020	0.04	0.070	0.16
04	6.3	1/4"	350	5075	1400	20300	0.040	0.08	0.120	0.26
06	10	3/8"	300	4350	1200	17400	0.070	0.16	0.220	0.49
08	12.5	1/2"	280	4060	1120	16240	0.102	0.23	0.322	0.72
12	20	3/4"	180	2610	720	10440	0.195	0.43	0.585	1.30
16	25	1"	150	2175	600	8700	0.370	0.82	0.860	1.91

* Referred to poppet valve couplings
 Riferite ad innesti con valvola a funghetto

POPPET VALVE
VAVOLA A FUNGHETTO

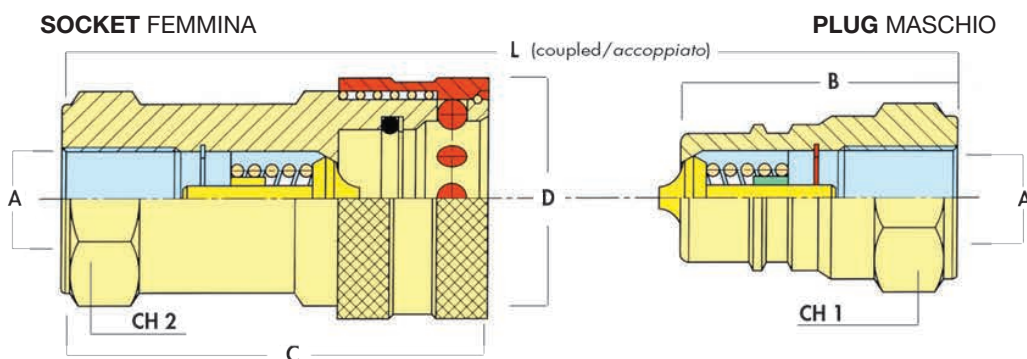

SIZE BASE	Ø DN		CODE CODICE		Ø A*	B		C		Ø D		L		CH 1		CH 2	
	mm	inch	plug maschio	socket femmina		mm	in	mm	in	mm	in	mm	in	mm	in	mm	in
04	6	1/4"	NM10-04	NF10-04	1/4" BSP	35	1.38	52	2.05	27	1.06	70.5	2.78	19	0.75	21	0.83
			NM15-04	NF15-04	1/4" NPTF												
06	10	3/8"	NM10-06	NF10-06	3/8" BSP	39	1.54	60	2.36	35	1.38	80	3.15	22	0.87	27	1.06
			NM15-06	NF15-06	3/8" NPTF												
			NM18-06	NF18-06	3/8" BSPT												
08	12	1/2"	AM10-08	AF10-08	1/2" BSP	45	1.77	67	2.64	38	1.50	92	3.62	27	1.06	30	1.18
			AM15-08	AF15-08	1/2" NPTF												
			AM18-08	AF18-08	1/2" BSPT												
12	20	3/4"	NM10-12	NF10-12	3/4" BSP	53	2.09	82	3.23	46	1.81	106.5	4.19	34	1.34	38	1.50
			NM15-12	NF15-12	3/4" NPTF												
16	25	1"	NM10-16	NF10-16	1" BSP	58	2.28	95	3.74	55	2.17	120	4.72	41	1.61	45	1.77
			NM15-16	NF15-16	1" NPTF												

BALL VALVE
VAVOLA A SFERA

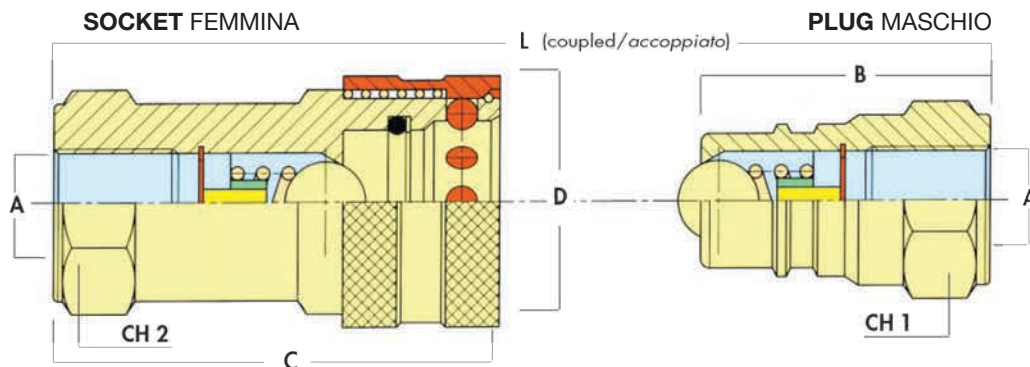

SIZE BASE	Ø DN		CODE CODICE		Ø A*	B		C		Ø D		L		CH 1		CH 2	
	mm	inch	plug maschio	socket femmina		mm	in	mm	in	mm	in	mm	in	mm	in	mm	in
04	6	1/4"	NM20-04	NF20-04	1/4" BSP	35	1.38	52	2.05	27	1.06	70.5	2.78	19	0.75	21	0.83
			NM25-04	NF25-04	1/4" NPTF												
06	10	3/8"	NM20-06	NF20-06	3/8" BSP	39	1.54	60	2.36	35	1.38	80	3.15	22	0.87	27	1.06
			NM25-06	NF25-06	3/8" NPTF												
			NM28-06	NF28-06	3/8" BSPT												
08	12	1/2"	AM20-08	AF20-08	1/2" BSP	45	1.77	67	2.63	38	1.50	92	3.62	27	1.06	30	1.18
			AM25-08	AF25-08	1/2" NPTF												
			AM28-08	AF28-08	1/2" BSPT												
12	20	3/4"	NM20-12	NF20-12	3/4" BSP	53	2.09	82	3.23	46	1.81	106.5	4.19	34	1.34	38	1.50
			NM25-12	NF25-12	3/4" NPTF												
16	25	1"	NM20-16	NF20-16	1" BSP	68.5	2.70	103	4.05	55	2.17	120	4.72	41	1.61	45	1.77
			NM25-16	NF25-16	1" NPTF												

* Other threads available on request Ulteriori filettature disponibili a richiesta.

MAIN DATA

Series N design, also known as agricultural interchange, is probably the most popular coupling design worldwide on agricultural applications. The size 1/2" is identical to series A, ISO 7241-A interchangeable.

- Available with both poppet and ball valve;
- Standard material: steel;
- Plugs treated with induction hardening;
- Internal valves in hardened steel;
- Standard seals in nitril rubber;
- Back-up seals in teflon;
- Working temperature with standard nitril seals: -20°C / +110°C;
- Special seals on request: Viton, EPDM, Neoprene;
- 1/2" plug and socket are also available in a special version allowing their connection in presence of residual back pressure.

CARATTERISTICHE PRINCIPALI

La serie N corrisponde al tipo di intercambiabilità più diffusa a livello internazionale per applicazioni relative a macchine ed attrezzature agricole. La misura 1/2" è identica alla serie A ed è quindi intercambiabile secondo la norma ISO 7241-A.

- Disponibile con valvola a funghetto o sfera;
- Materiale standard: acciaio;
- Parte maschio in acciaio temprato ad induzione;
- Valvole interne in acciaio temprato;
- Guarnizioni standard in gomma nitrilica;
- Anelli antiestrusione in teflon;
- Temperature esercizio con guarnizioni standard: -20°C / +110°C;
- Guarnizioni speciali a richiesta: Viton, EPDM, Neoprene;
- Gli innesti maschio e femmina da 1/2" sono disponibili anche in una versione speciale che permette il loro aggancio in presenza di pressioni residue.

PRESSURE DROP GRAPH GRAFICO PERDITE DI CARICO *

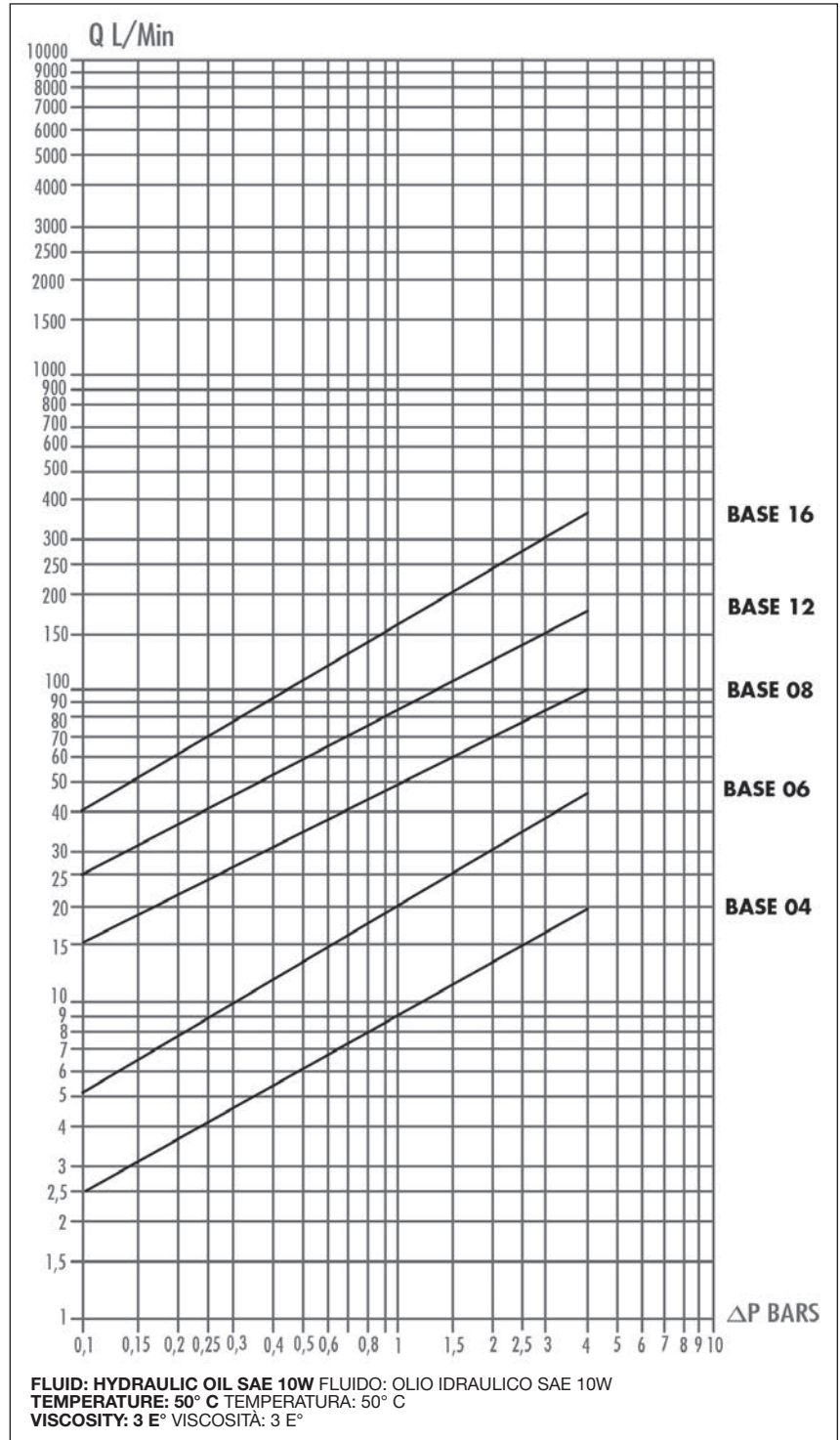

PERFORMANCES PRESTAZIONI

SIZE BASE	Ø DN		MAX WORK PRESSURE MAX PRESS. ESERCIZIO		BURST PRESSURE PRESSIONE SCOPPIO		WEIGHT PESO			
	mm	inch	bar	psi	bar	psi	plug maschio		socket femmina	
							kg	lbs	kg	lbs
04	6	1/4"	350	5075	1400	20300	0.04	0.08	0.10	0.22
06	10	3/8"	315	4567.5	1260	18270	0.07	0.15	0.20	0.44
08	12	1/2"	250	3625	1000	14500	0.09	0.20	0.26	0.57
12	20	3/4"	250	3625	1000	14500	0.18	0.40	0.50	1.11
16	25	1"	230	3335	920	13340	0.23	0.51	0.76	1.68

* These pressure drops are referred to poppet valve couplings Perdite di carico riferite ad innesti con valvola a funghetto.

P series

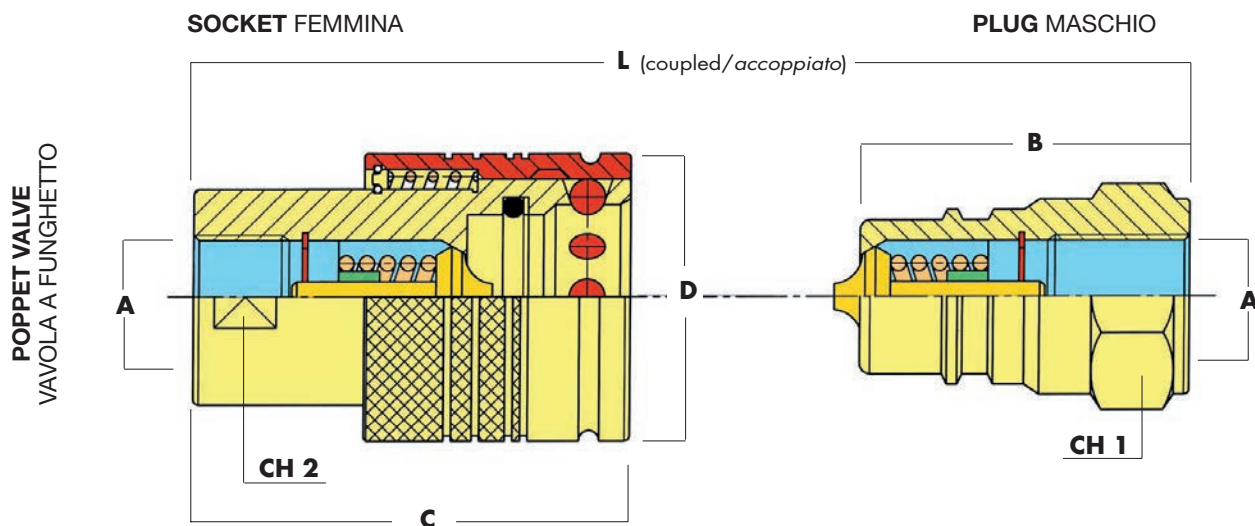

SIZE BASE	Ø DN		CODE CODICE		Ø A*	B		C		Ø D		L		CH 1		CH 2	
	mm	inch	plug maschio	socket femmina		mm	in	mm	in	mm	in	mm	in	mm	in	mm	in
08	12	1/2"	AM10-08	PF10-08	1/2"BSP	46	1.81	67	2.64	38	1.50	92	3.62	27	1.06	24	0.94
			AM15-08	PF15-08	1/2"NPT												

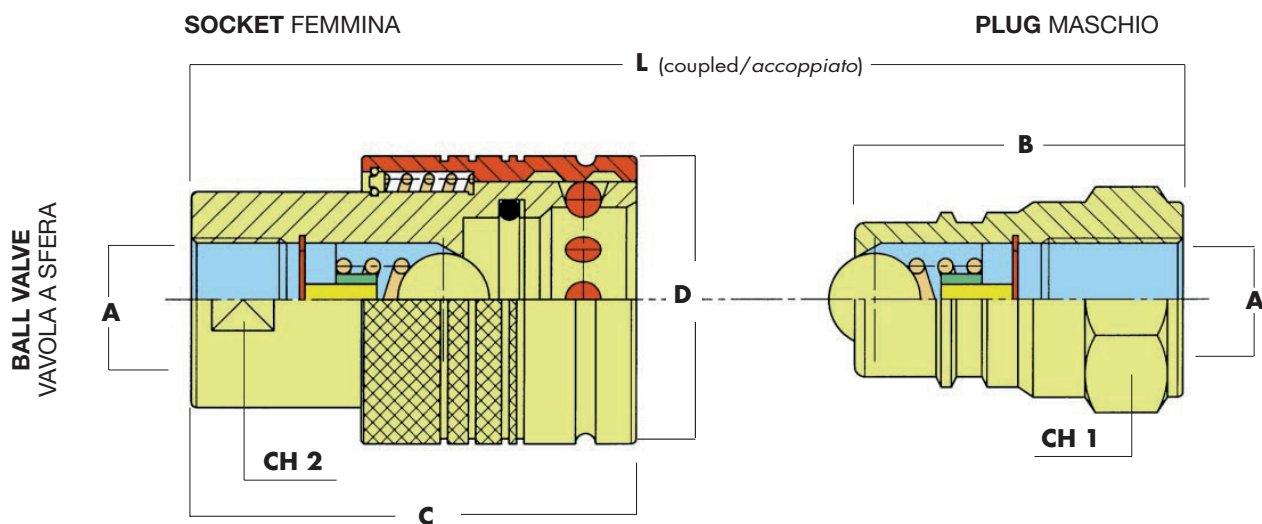

SIZE BASE	Ø DN		CODE CODICE		Ø A*	B		C		Ø D		L		CH 1		CH 2	
	mm	inch	plug maschio	socket femmina		mm	in	mm	in	mm	in	mm	in	mm	in	mm	in
08	12	1/2"	AM20-08	PF20-08	1/2"BSP	46	1.81	67	2.64	38	1.50	92	3.62	27	1.06	24	0.94
			AM25-08	PF25-08	1/2"NPT												

* Other threads available on request Ulteriori filettature disponibili a richiesta.

MAIN DATA

The P series push-pull couplings are interchangeable according to ISO 7241-A and ISO 5675.

These couplings are normally adopted on agricultural implements and applications; the possible panel mounting allows to easily connect and disconnect plug and socket with one hand only.

P series couplings are available with both poppet valve and ball valve; the standard thread are BSP, NPTF and metric male 24° according to DIN 2353.

- Poppet or ball valves;
- Interchangeable ISO 7241-A and ISO- 5675;
- Material: steel;
- Poppet valve in hardened steel;
- Plug in hardened steel;
- Working temperatures with standard seals -20°C / +110°C;

Standard seals in nitril rubber; Back-up ring in PTFE.

Special features:

A special valve is available on request to allow the plug to be connected in presence of residual back pressure.

CARATTERISTICHE PRINCIPALI

Gli innesti rapidi push-up serie P sono disponibili con valvola a funghetto o a sfera in varie opzioni di filettatura: BSP, NPT e metrica 24° DIN 2353.

Questa serie viene tipicamente utilizzata su macchine ed attrezzature agricole dove si caratterizza per la possibilità di montaggio a parete con il possibile aggancio/sgancio con una sola mano.

Questo innesto è intercambiabile secondo le normative ISO 7241-A e ISO-5675.

- Valvola a funghetto o sfera;
- Materiale: acciaio;
- Valvola a funghetto in acciaio temprato;
- Guarnizioni standard in gomma nitrilica;
- Anelli antiestrusione in PTFE;
- Temperature esercizio con guarnizioni standard: -20°C / +110°C;

Opzioni speciali:

L'innesto è disponibile con una valvola speciale che permette aggancio anche in presenza di pressioni residue.

PRESSURE DROP GRAPH GRAFICO PERDITE DI CARICO

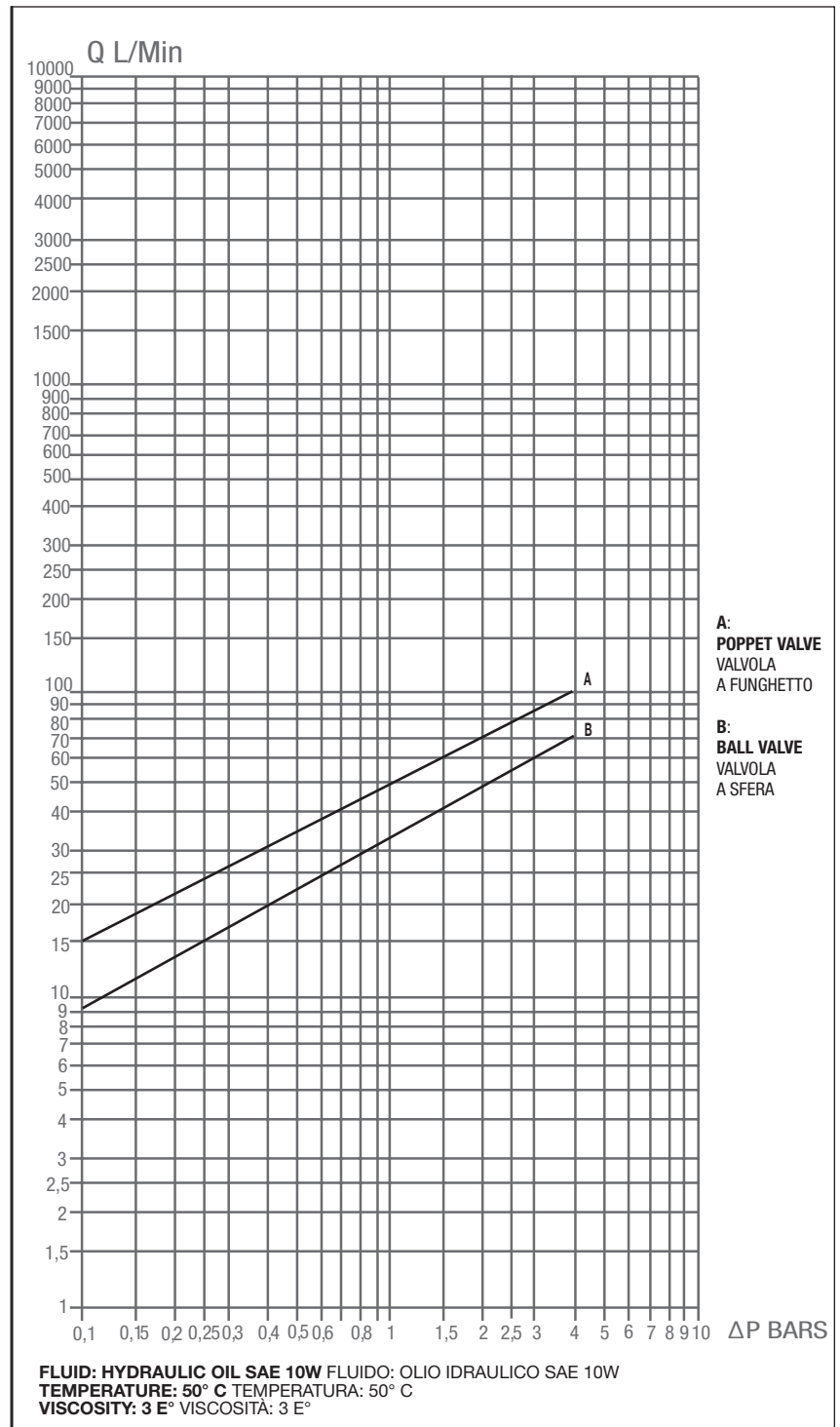

PERFORMANCES PRESTAZIONI

SIZE BASE	Ø DN		MAX WORK PRESSURE MAX PRESS. ESERCIZIO		BURST PRESSURE PRESSIONE SCOPPIO		WEIGHT PESO			
	mm	inch	bar	psi	bar	psi	plug maschio		socket femmina	
							kg	lbs	kg	lbs
08	12	1/2"	250	3625	1000	14500	0.090	0.200	0.200	0.613

SOCKET FEMMINA

PLUG MASCHIO

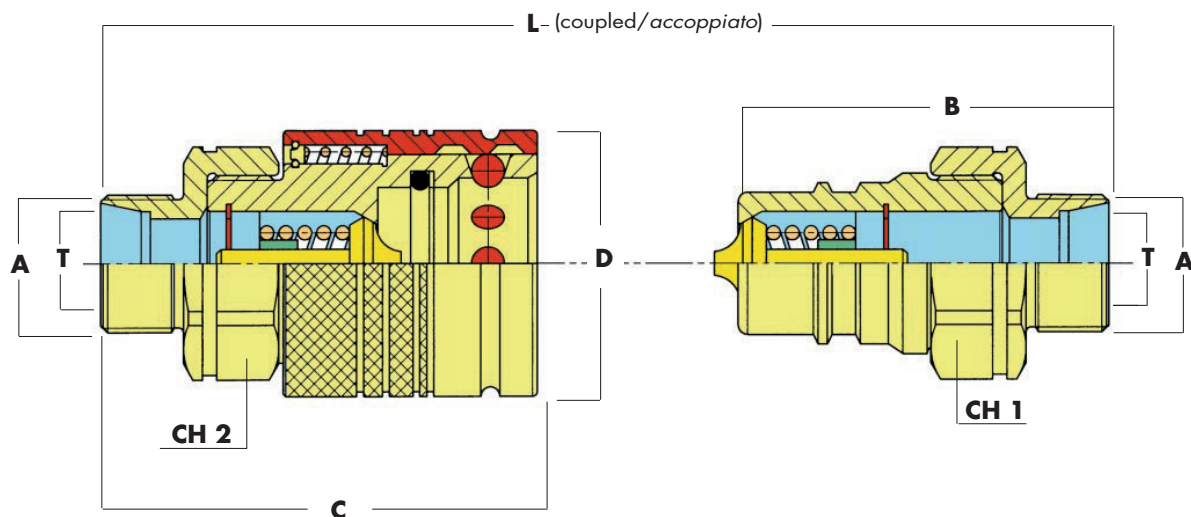

L

SIZE BASE	Ø DN		CODE CODICE		Ø T	Ø A*	B		C		Ø D		L		CH 1		CH 2	
	mm	inch	plug maschio	socket femmina			mm	in	mm	in	mm	in	mm	in	mm	in	mm	in
08	12	1/2"	AM11-08L	PF11-08L	8	M14X1.5	56	2.20	76	2.99	38	1.50	111	4.37	30	1.18	30	1.18
			AM11-10L	PF11-10L	10	M16X1.5	57	2.24	77	3.03	38	1.50	113	4.45	30	1.18	30	1.18
			AM11-12L	PF11-12L	12	M18X1.5	57	2.24	77	3.03	38	1.50	113	4.45	30	1.18	30	1.18
			AM11-15L	PF11-15L	15	M22X1.5	58	2.28	78	3.07	38	1.50	115	4.53	30	1.18	30	1.18
			AM11-18L	PF11-18L	18	M26X1.5	58	2.28	78	3.07	38	1.50	115	4.53	30	1.18	30	1.18

S

SIZE BASE	Ø DN		CODE CODICE		Ø T	Ø A*	B		C		Ø D		L		CH 1		CH 2	
	mm	inch	plug maschio	socket femmina			mm	in	mm	in	mm	in	mm	in	mm	in	mm	in
08	12	1/2"	AM12-08S	PF12-08S	8	M16X1.5	58	2.28	78	3.07	38	1.50	115	4.53	30	1.18	30	1.18
			AM12-10S	PF12-10S	10	M18X1.5	58	2.28	78	3.07	38	1.50	115	4.53	30	1.18	30	1.18
			AM12-12S	PF12-12S	12	M20X1.5	58	2.28	78	3.07	38	1.50	115	4.53	30	1.18	30	1.18
			AM12-14S	PF12-14S	14	M22X1.5	60	2.36	80	3.15	38	1.50	119	4.69	30	1.18	30	1.18
			AM12-16S	PF12-16S	16	M24X1.5	60	2.36	80	3.15	38	1.50	119	4.69	30	1.18	30	1.18
			AM12-20S	PF12-20S	20	M30X2	62	2.44	82	3.23	38	1.50	123	4.84	30	1.18	30	1.18

* Other threads available on request Ulteriori filettature disponibili a richiesta.

SOCKET FEMMINA

PLUG MASCHIO

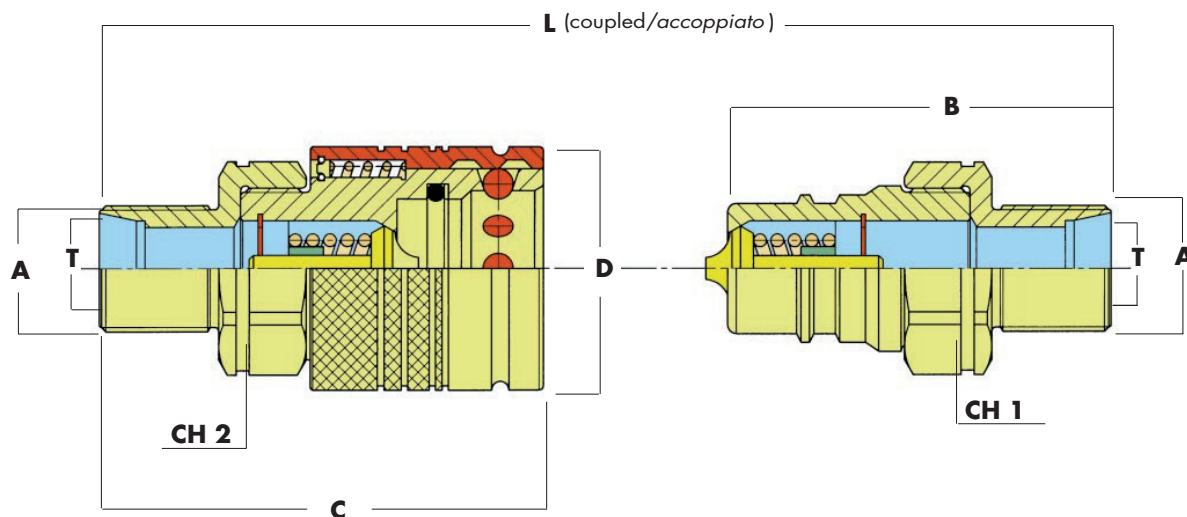

L

SIZE BASE	Ø DN		CODE CODICE		Ø T	Ø A*	B		C		Ø D		L		CH 1		CH 2	
	mm	inch	plug maschio	socket femmina			mm	in	mm	in	mm	in	mm	in	mm	in	mm	in
08	12	1/2"	AM13-08L	PF13-08L	8	M14X1.5	72	2.83	92	3.62	38	1.50	143	5.63	30	1.18	30	1.18
			AM13-10L	PF13-10L	10	M16X1.5	72	2.83	92	3.62	38	1.50	143	5.63	30	1.18	30	1.18
			AM13-12L	PF13-12L	12	M18X1.5	72	2.83	92	3.62	38	1.50	143	5.63	30	1.18	30	1.18
			AM13-15L	PF13-15L	15	M22X1.5	73	2.87	93	3.66	38	1.50	145	5.71	30	1.18	30	1.18
			AM13-18L	PF13-18L	18	M26X1.5	73	2.87	93	3.66	38	1.50	145	5.71	30	1.18	30	1.18

S

SIZE BASE	Ø DN		CODE CODICE		Ø T	Ø A*	B		C		Ø D		L		CH 1		CH 2	
	mm	inch	plug maschio	socket femmina			mm	in	mm	in	mm	in	mm	in	mm	in	mm	in
08	12	1/2"	AM14-08S	PF14-08S	8	M16X1.5	73	2.87	93	3.66	38	1.50	145	5.71	30	1.18	30	1.18
			AM14-10S	PF14-10S	10	M18X1.5	73	2.87	93	3.66	38	1.50	145	5.71	30	1.18	30	1.18
			AM14-12S	PF14-12S	12	M20X1.5	73	2.87	93	3.66	38	1.50	145	5.71	30	1.18	30	1.18
			AM14-14S	PF14-14S	14	M22X1.5	75	2.95	95	3.74	38	1.50	149	5.87	30	1.18	30	1.18
			AM14-16S	PF14-16S	16	M24X1.5	75	2.95	95	3.74	38	1.50	149	5.87	30	1.18	30	1.18
			AM14-20S	PF14-20S	20	M30X2	78	3.07	98	3.86	38	1.50	155	6.10	30	1.18	30	1.18

* Other threads available on request Ulteriori filettature disponibili a richiesta.

E series

SOCKET FEMMINA

PLUG MASCHIO

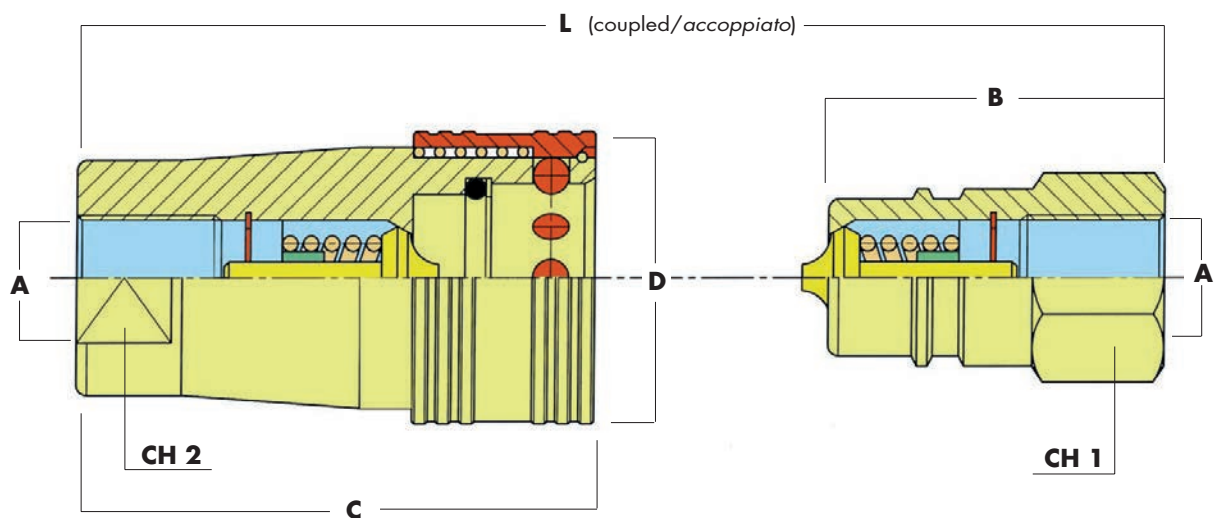

SIZE BASE	Ø DN		CODE CODICE		Ø A*	B		C		Ø D		L		CH 1		CH 2	
	mm	inch	plug maschio	socket femmina		mm	in	mm	in	mm	in	mm	in	mm	in	mm	in
20	32	1.1/4"	EM10-20	EF10-20	1.1/4" BSP	70	2.76	110	4.33	70	2.75	140	5.51	50	1.97	50	1.97
			EM15-20	EF15-20	1.1/4" NPTF												
24	38	1.1/2"	EM10-24	EF10-24	1.1/2" BSP	70	2.76	114	4.49	81	3.18	141	5.55	60	2.36	55	2.17
			EM15-24	EF15-24	1.1/2" NPTF												
32	50	2"	EM10-32	EF10-32	2" BSP	89	3.50	139	5.47	114	4.49	177	6.97	70	2.76	70	2.76
			EM15-32	EF15-32	2" NPTF												
40	63	2.1/2"	EM10-40	EF10-40	2.1/2" BSP	89	3.50	139	5.47	114	4.49	177	6.97	84	3.30	84	3.30
			EM15-40	EF15-40	2.1/2" NPTF												
50	76	3"	EM10-50	EF10-50	3" BSP	100	3.94	155	6.10	139	5.47	200	7.87	100	3.94	100	3.94
			EM15-50	EF15-50	3" NPTF												

* Other threads available on request Ulteriori filettature disponibili a richiesta.

MAIN DATA

Series E includes large diameter couplings which find their ideal application in medium pressure hydraulic and industrial applications.

- Standard material: steel;
- Plugs treated with induction hardening;
- Internal valves in hardened steel;
- Standard seals in nitril rubber;
- Working temperature: -20°C / +110°C;

On request:

- Special seals: Viton, EPDM, Neoprene;
- Free flow version;
- Brass version;

CARATTERISTICHE PRINCIPALI

La serie E comprende innesti di grosso diametro che trovano utilizzo ideale in applicazioni a media pressione nei settori oleodinamico ed industriale.

- Materiale standard: acciaio;
- Parte maschio in acciaio temprato ad induzione;
- Valvole interne in acciaio;
- Guarnizione standard in gomma nitrilica;
- Temperature di esercizio con guarnizioni standard: -20°C / +110°C;

A richiesta:

- Guarnizioni speciali: Viton, EPDM, Neoprene;
- Versioni a passaggio libero;
- Versioni in ottone;

PRESSURE DROP GRAPH GRAFICO PERDITE DI CARICO

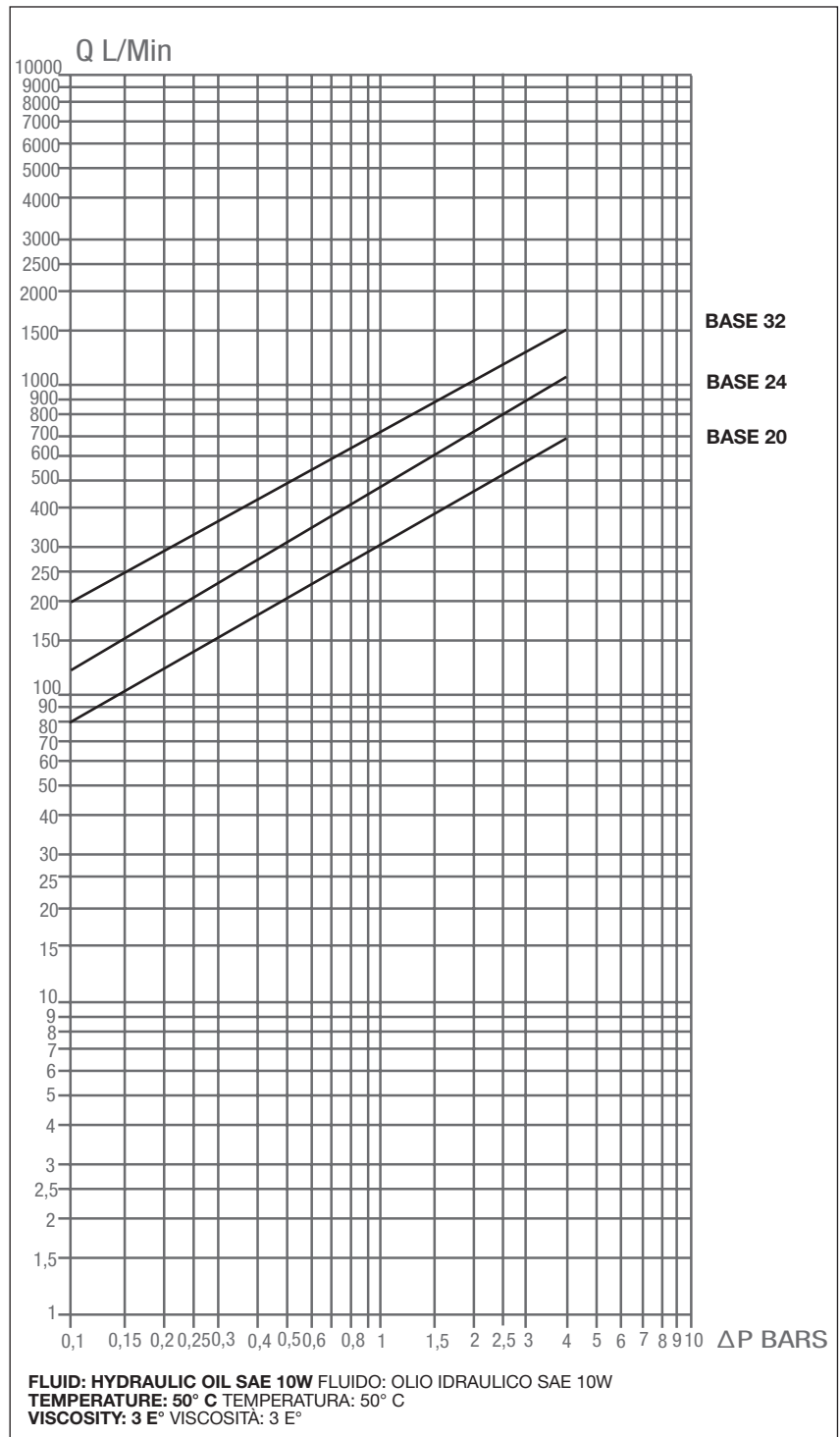

PERFORMANCES PRESTAZIONI

SIZE BASE	Ø DN		MAX WORK PRESSURE MAX PRESS. ESERCIZIO		BURST PRESSURE PRESSIONE SCOPPIO		WEIGHT PESO			
	mm	inch	bar	psi	bar	psi	plug maschio		socket femmina	
							kg	lbs	kg	lbs
20	32	1.1/4"	140	2030	560	8120	0.46	1.02	1.38	3.07
24	38	1.1/2"	120	1740	480	6960	0.72	1.60	1.82	4.04
32	50	2"	120	1740	480	6960	2.02	4.49	4.42	9.82
40	63	2.1/2"	100	1450	400	5800	1.82	4.04	4.05	9.00
50	76	3"	70	1015	280	4060	3.23	7.17	7.00	15.50

SOCKET FEMMINA

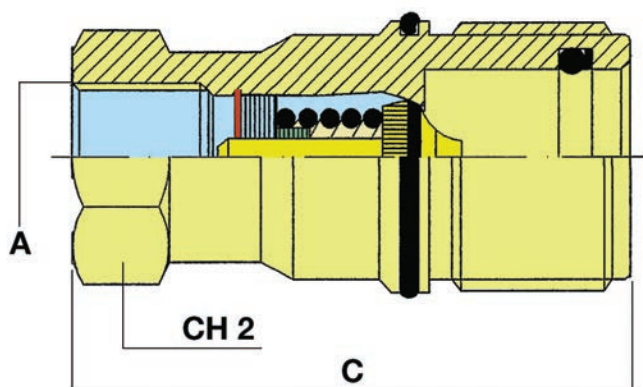

$\leq 1/2''$ PLUG MASCHIO

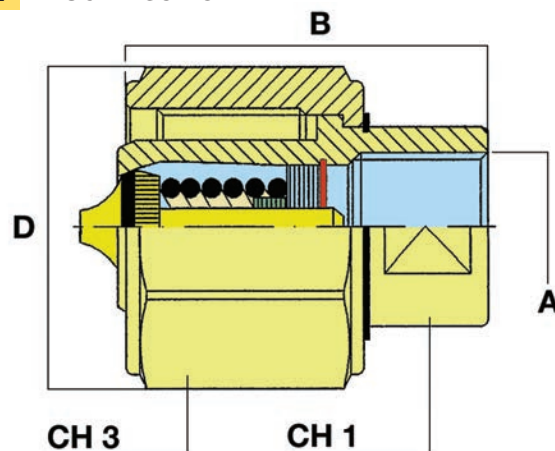

$\cong 3/4''$ PLUG MASCHIO

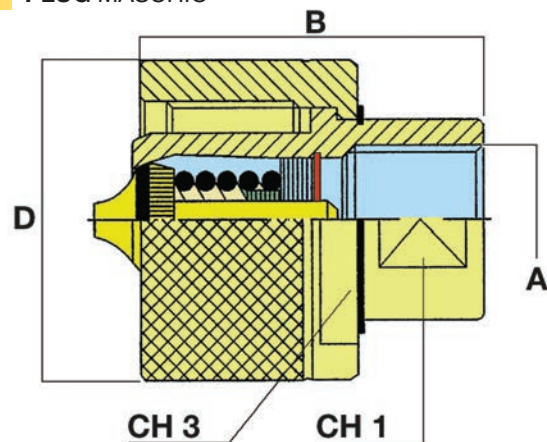

$\geq 2''$ PLUG MASCHIO

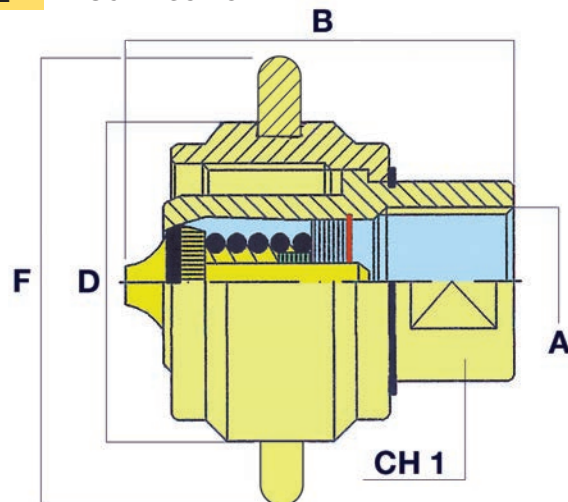

SIZE BASE	Ø DN		CODE CODICE		Ø A*	B		C		Ø D		L		CH 1		CH 2		CH 3	
	mm	inch	plug maschio	socket femmina		mm	in	mm	in	mm	in	mm	in	mm	in	mm	in	mm	in
04	6	1/4"	SM10-04	SF10-04	1/4"BSP	46	1.81	50	1.97	31	1.22	72	2.83	17	0.70	19	0.75	28	1.10
06	10	3/8"	SM10-06	SF10-06	3/8"BSP	51	2.01	58	2.28	38	1.50	83	3.27	20	0.79	27	1.06	34	1.34
08	12	1/2"	SM10-08	SF10-08	1/2"BSP	54.5	2.14	75	2.95	47	1.85	100	3.94	27	1.06	32	1.26	42	1.65
12	20	3/4"	SM10-12	SF10-12	3/4"BSP	60	2.36	91	3.58	50	1.97	118	4.64	32	1.26	38	1.50	45	1.77
16	25	1"	SM10-16	SF10-16	1"BSP	70	2.75	89	3.50	60	2.36	120	4.72	41	1.61	45	1.77	55	2.16
20	32	1.1/4"	SM10-20	SF10-20	1.1/4"BSP	78	3.07	105	4.13	70	2.75	141	5.55	50	1.97	55	2.16	65	2.56
24	38	1.1/2"	SM10-24	SF10-24	1.1/2" BSP	80	3.15	105	4.13	90	3.54	141	5.55	55	2.16	60	2.36	75	2.95
SIZE BASE	Ø DN		CODE CODICE		Ø A*	B		C		Ø D		L		CH 1		CH 2		F**	
	mm	inch	plug maschio	socket femmina		mm	in	mm	in	mm	in	mm	in	mm	in	mm	in	mm	in
32	50	2"	SM10-32	SF10-32	2"BSP	96	3.78	130	5.12	135	5.31	172	6.77	80	3.15	80	3.15	220	8.66

* Other threads available on request Ulteriori filettature disponibili a richiesta.

** N°2 handles at 180° N°2 maniglie a 180°

MAIN DATA

Series S is a screw to connect coupling range available in sizes from 1/4" to 2 1/2". This series is used in heavy duty hydraulic and industrial applications in presence of high pressure, vibrations, mechanical stresses.

- Standard material: carbon steel;
- Internal valves in hardened steel;
- Standard seals in nitril rubber;
- Back-up seals in teflon;
- Working temperature with standard seals: -20°C / +110°C;
- Special seals on request: Viton, EPDM, Neoprene;

CARATTERISTICHE PRINCIPALI

La serie S comprende innesti a vite in una gamma di dimensioni dal 1/4" a 2 1/2".

Si tratta di innesti particolarmente robusti, adatti alle più gravose applicazioni oleodinamiche ed industriali. Questi innesti vengono di solito adottati in presenza di alte pressioni pulsanti, vibrazioni e altre forti sollecitazioni meccaniche.

- Materiale standard: acciaio al carbonio;
- Valvole interne in acciaio temprato;
- Guarnizioni standard in gomma nitrilica;
- Anelli antiestrusione in teflon;
- Temperature di esercizio con guarnizioni standard: -20°C / +110°C;
- Guarnizioni speciali a richiesta: Viton, EPDM, Neoprene.

PRESSURE DROP GRAPH GRAFICO PERDITE DI CARICO

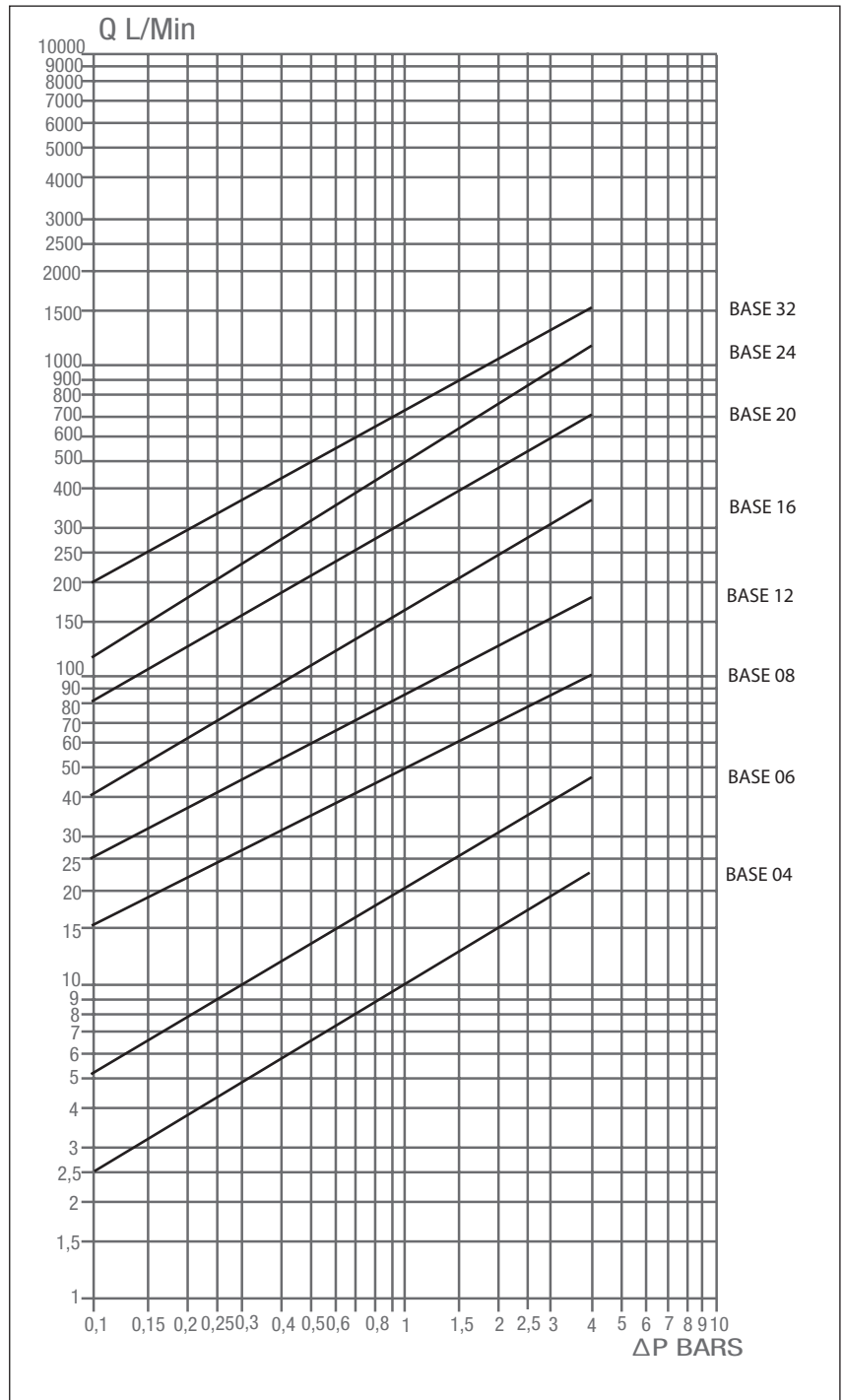

FLUID: HYDRAULIC OIL SAE 10W FLUIDO: OLIO IDRAULICO SAE 10W
 TEMPERATURE: 50° C TEMPERATURA: 50° C
 VISCOSITY: 3 E° VISCOSITÀ: 3 E°

PERFORMANCES PRESTAZIONI

SIZE BASE	Ø DN		MAX WORK PRESSURE MAX PRESS. ESERCIZIO		BURST PRESSURE PRESSIONE SCOPPIO		WEIGHT PESO			
							plug maschio		socket femmina	
	mm	inch	bar	psi	bar	psi	kg	lbs	kg	lbs
04	6	1/4"	450	6525	1800	26100	0,107	0,240	0,090	0,200
06	10	3/8"	450	6525	1800	26100	0,170	0,375	0,160	0,350
08	12	1/2"	400	5800	1600	23200	0,280	0,620	0,340	0,750
12	20	3/4"	350	5075	1400	20300	0,395	0,870	0,530	1,170
16	25	1"	350	5075	1400	20300	0,635	1,400	0,720	1,590
20	32	1.1/4"	250	3625	1000	14500	0,920	2,028	1,200	2,650
24	38	1.1/2"	220	3190	880	12700	1,240	2,734	1,350	2,980
32	50	2"	200	2900	800	11600	4,460	9,833	3,920	8,640

J series

SOCKET FEMMINA

PLUG MASCHIO

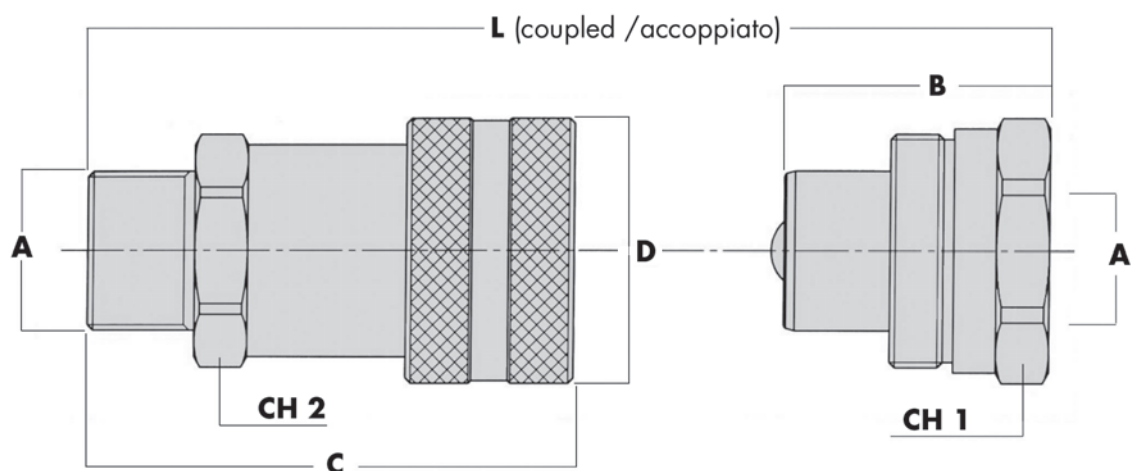

SIZE BASE	Ø DN		CODE CODICE		Ø A	B		C		Ø D		L		CH 1		CH 2	
	mm	inch	plug maschio	socket femmina		mm	in	mm	in	mm	in	mm	in	mm	in	mm	in
04	5	1/4"	JM25-04	JF25-04	1/4"NPT	32.5	1.28	60.8	2.39	28	1.10	74.5	2.93	19	0.75	22	0.87
06	7	1/4"	JMX25-04	JFX25-04	1/4"NPT	40	1.57	72.3	2.85	35	1.38	86.9	3.42	32	1.26	24	0.94
06	7	3/8"	JM25-06	JF25-06	3/8"NPT	40	1.57	72.3	2.85	35	1.38	86.9	3.42	32	1.26	24	0.94

PERFORMANCES PRESTAZIONI

SIZE BASE	Ø DN		MAX WORK PRESSURE MAX PRESS. ESERCIZIO		BURST PRESSURE* PRESSIONE SCOPPIO		WEIGHT PESO			
	mm	inch	bar	psi	bar	psi	plug maschio		socket femmina	
							kg	lbs	kg	lbs
04	5	1/4"	700	10150	2200	31900	0.080	0.177	0.150	0.330
04	7	1/4"	700	10150	1850	26825	0.120	0.266	0.200	0.444
06	7	3/8"	700	10150	1850	26825	0.120	0.266	0.200	0.444

* Coupled Innesto accoppiato

MAIN DATA

J series includes screw to connect couplings designed to match the very high pressures used for hydraulic tools.

- Screw to connect;
- Material: steel;
- Ball valve;
- Silver colour zinc passivation;
- Standard seals in nitril rubber;
- Back-up seals in teflon;
- Working temperature with standard seals: -20°C / +110°C;
- Metal caps on request;

CARATTERISTICHE PRINCIPALI

La serie J comprende innesti a vite per le altissime pressioni tipicamente utilizzate negli utensili idraulici.

- Meccanismo di innesto a vite;
- Materiale: acciaio;
- Valvola a sfera;
- Zincatura bianca;
- Guarnizioni standard in gomma nitrilica;
- Anelli antiestrusione in teflon;
- Temperature di esercizio con guarnizioni standard: -20°C / +110°C;
- Tappi di metallo a richiesta;

PW series

SOCKET FEMMINA

PLUG MASCHIO

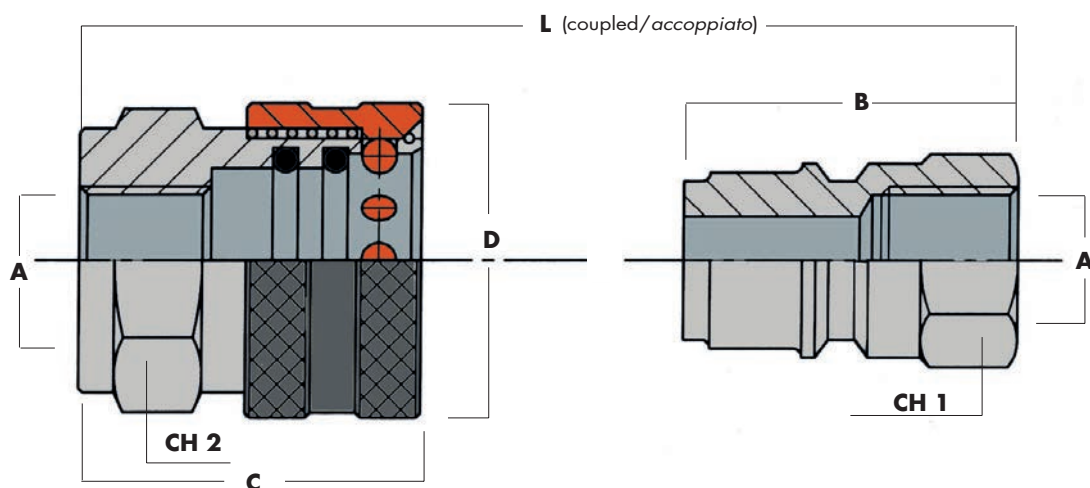

SIZE BASE	Ø DN		CODE CODICE		Ø A	B		C		Ø D		L		CH 1		CH 2	
	mm	inch	plug maschio	socket femmina		mm	in	mm	in	mm	in	mm	in	mm	in	mm	in
06	10	3/8"	PWM00-06	PWF00-06	3/8"BSP	38	1.50	39	1.54	35	1.38	53.5	2.11	22	0.87	30	1.18

PERFORMANCES PRESTAZIONI

SIZE BASE	Ø DN		MAX WORK PRESSURE MAX PRESS. ESERCIZIO		BURST PRESSURE PRESSIONE SCOPPIO		WEIGHT PESO			
	mm	inch	bar	psi	bar	psi	plug maschio		socket femmina	
							kg	lbs	kg	lbs
06	10	3/8"	250	3600	625	9000	0.020	0.04	0.070	0.16

MAIN DATA

PW series includes free flow couplings for water, steam and other media used in industrial applications.

- Socket in chromed plated brass;
- Locking sleeve in steel treated with Q.P.Q;
- Plug in hardened steel;
- Two viton seals;
- Working temperature with standard seals: -15°C / +180°C;
- Special seals on request;

CARATTERISTICHE PRINCIPALI

La serie PW comprende innesti a passaggio libero per acqua, vapore e altri fluidi usati nel settore industriale.

- Corpo femmina in ottone cromato;
- Ghiera di ritenzione in acciaio trattato con Q.P.Q;
- Maschio in acciaio temprato ad induzione;
- Doppia guarnizione in viton;
- Temperature di esercizio: -15°C / +180°C;
- Guarnizioni speciali a richiesta;

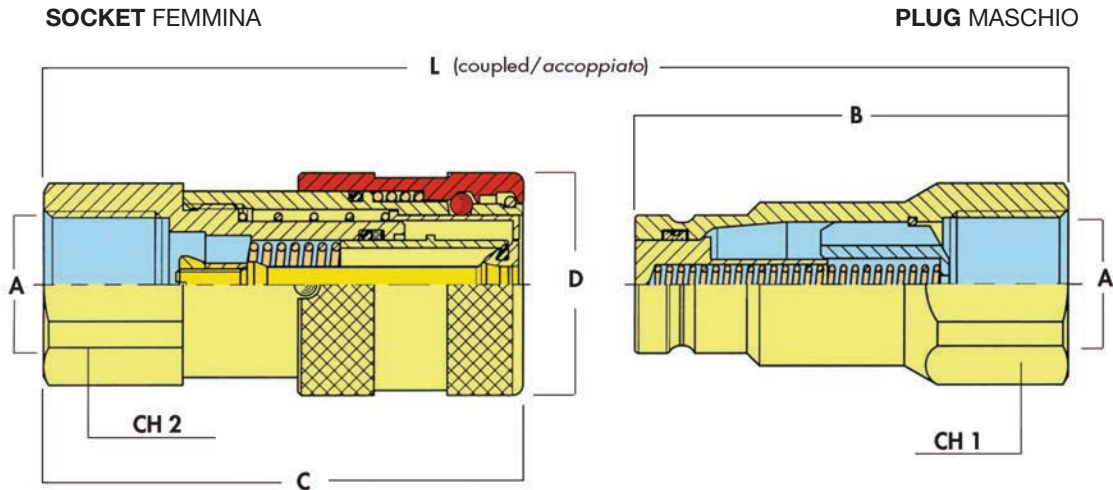

SIZE BASE	Ø DN mm	CODE CODICE		Ø A*	B		C		Ø D		L		CH 1		CH 2	
		plug maschio	socket femmina		mm	in	mm	in	mm	in	mm	in	mm	in	mm	in
04	7	FM10-04	FF10-04	1/4" BSP	48	1.89	48	1.89	28	1.10	85.5	3.37	22	0.87	22	0.87
		FM15-04	FF15-04	1/4" NPTF												
		FM18-04	FF18-04	1/4" BSPT												
06	9	FM10-06	FF10-06	3/8" BSP	60	2.36	64.5	2.54	32	1.26	109	4.29	24	0.94	27	1.06
		FM15-06	FF15-06	3/8" NPTF												
		FM18-06	FF18-06	3/8" BSPT												
06	9	FM10-08	FF10-08	1/2" BSP	62.5	2.46	69.5	2.74	32	1.26	117	4.59	27	1.06	27	1.06
		FM15-08	FF15-08	1/2" NPTF												
		FM18-08	FF18-08	1/2" BSPT												
08	13	FM20-08	FF20-08	1/2" BSP	68	2.68	73.5	2.89	38	1.50	125	4.92	32	1.26	32	1.26
		FM25-08	FF25-08	1/2" NPTF												
		FM28-08	FF28-08	1/2" BSPT												
08	13	FM10-12	FF10-12	3/4" BSP	70.5	2.78	80.5	3.17	38	1.50	135	5.30	36	1.42	36	1.42
		FM15-12	FF15-12	3/4" NPTF												
		FM18-12	FF18-12	3/4" BSPT												
12	15	FM20-12	FF20-12	3/4" BSP	70.5	2.78	78	3.07	42	1.65	132	5.20	36	1.42	36	1.42
		FM25-12	FF25-12	3/4" NPTF												
		FM28-12	FF28-12	3/4" BSPT												
16	17	FM10-16	FF10-16	1" BSP	82.5	3.25	92.5	3.64	48	1.89	154	6.06	45	1.77	45	1.77
		FM15-16	FF15-16	1" NPTF												
		FM18-16	FF18-16	1" BSPT												
20	21	FM10-20	FF10-20	1.1/4" BSP	90	3.54	105	4.13	55	2.17	173	6.81	55	2.17	55	2.17
		FM15-20	FF15-20	1.1/4" NPTF												
		FM18-20	FF18-20	1.1/4" BSPT												
24	30	FM10-24	FF10-24	1.1/2" BSP	111	4.37	133	5.22	80	3.15	215	8.46	70	2.76	65	2.56
		FM15-24	FF15-24	1.1/2" NPTF												
		FM18-24	FF18-24	1.1/2" BSPT												
32	45	FM10-32	FF10-32	2" BSP	125	4.92	165	6.50	100	3.94	250	9.84	75	2.95	80	3.15
		FM15-32	FF15-32	2" NPTF												
		FM18-32	FF18-32	2" BSPT												

* Other threads available on request Ulteriori filettature disponibili a richiesta.

MAIN DATA

Series F flat face couplings are adopted on the most diversified hydraulic and industrial applications. The F series flat face design offers important technical advantages:

- Perfect sealing of plug and socket both when coupled and uncoupled;
- Extremely low spillage during connection and disconnection;
- No inclusion of air or external media during connection and disconnection;
- The flat faces are easy to clean;
- Sleeve with a safety device preventing from accidental disconnection;
- Standard seals in nitril rubber;
- Antiextrusion ring in teflon;
- Working temperature with standard seals: -20°C +110°C;
- Body size 3/8 (DN 9) is interchangeable according to HTMA design;
- Special seals on request: Viton, EPDM,

CARATTERISTICHE PRINCIPALI

Gli innesti a facce piane serie F trovano applicazione in molti settori oleodinamici e industriali, offrendo tutti i vantaggi tipici di questo concetto costruttivo:

- Tenuta totale con innesti separati e accoppiati;
- Perdite di fluido bassissime nelle fasi di accoppiamento e sgancio;
- Nessuna intrusione di agenti esterni durante le connessioni;
- Facile pulizia delle superfici di accoppiamento;
- Ghiera con sistema antisgancio;
- Guarnizioni standard in gomma nitrilica;
- Anelli antiestrusione in teflon;
- Temperature d'esercizio con guarnizioni standard: -20°C/+110°C;
- Misura 3/8 (DN 9) intercambiabile secondo norme HTMA;
- Guarnizioni speciali a richiesta: Viton, EPDM;

PRESSURE DROP GRAPH GRAFICO PERDITE DI CARICO

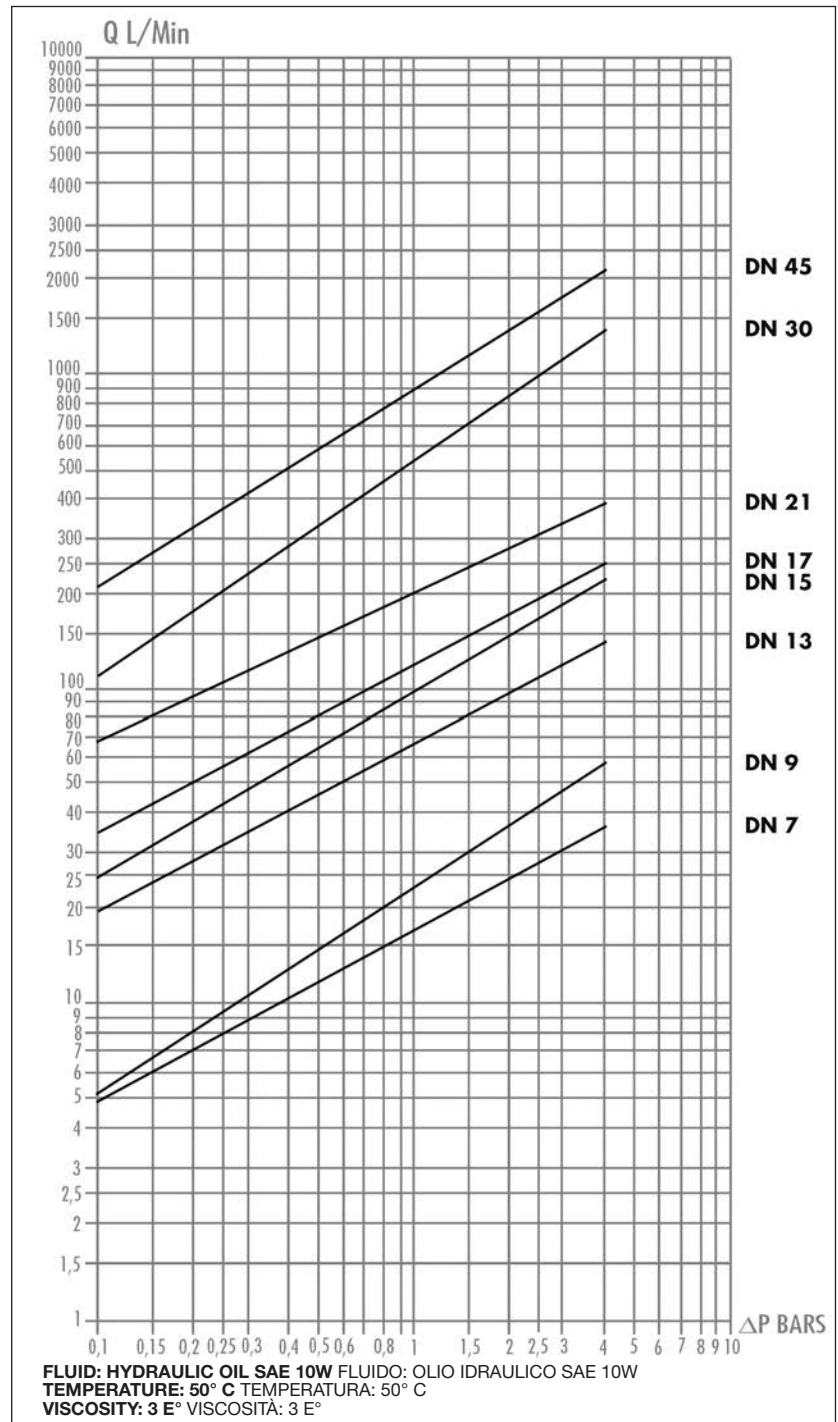

PERFORMANCES PRESTAZIONI

SIZE BASE	Ø DN	MAX WORK PRESSURE		MIN. BURST PRESSURE PRESSIONE SCOPPIO						WEIGHT PESO				FORCE TO CONNECT FORZA AGGANCIO	
				coupled accoppiato		plug maschio		socket femmina		plug maschio		socket femmina			
				mm	bar	psi	bar	psi	bar	psi	bar	psi	kg	lbs	kg
04	7	300	4350	1200	17400	1200	17400	600	8700	0.045	0.100	0.080	0.18	18	40.00
06	9	300	4350	1200	17400	1200	17400	600	8700	0.055	0.122	0.150	0.33	17	37.78
06	9	300	4350	1200	17400	1200	17400	600	8700	0.090	0.200	0.270	0.60	17	37.78
08	13	250	3625	1000	14500	1000	14500	400	5800	0.090	0.200	0.270	0.60	18	40.00
08	13	250	3625	1000	14500	1000	14500	400	5800	0.185	0.410	0.465	1.03	18	40.00
12	15	250	3625	1000	14500	900	13050	450	6525	0.185	0.410	0.465	1.03	20	44.44
16	17	250	3625	850	12325	920	13340	550	7975	0.270	0.600	0.720	1.60	25	55.56
20	21	250	3625	850	12325	920	13340	470	6815	0.600	1.330	1.250	2.78	31	68.89
24	30	200	2900	700	10150	700	10150	300	4350	0.900	2.000	2.100	4.67	43	95.56
32	45	180	2610	700	10150	700	10150	500	7250	1.450	3.220	4.150	9.22	50	111.11

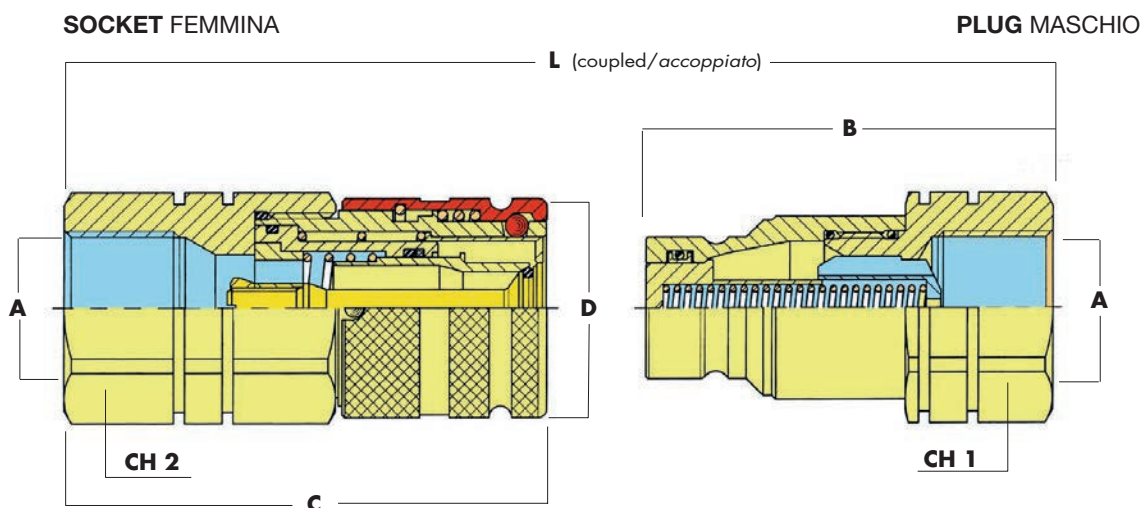

SIZE BASE	Ø DN mm	CODE CODICE		Ø A*	B		C		Ø D		L		CH 1		CH 2	
		plug maschio	socket femmina		mm	in	mm	in	mm	in	mm	in	mm	in	mm	in
02	4	FAM10-02	FAF10-02	1/8" BSP	36.5	1.44	40	1.57	20	0.79	68.5	2.70	17	0.67	19	0.75
		FAM15-02	FAF15-02	1/8" NPTF												
		FAM18-02	FAF18-02	1/8" BSPT												
04	7	FAM10-04	FAF10-04	1/4" BSP	48	1.89	53	2.09	28	1.10	90.5	3.56	22	0.87	27	1.06
		FAM15-04	FAF15-04	1/4" NPTF												
		FAM18-04	FAF18-04	1/4" BSPT												
06	9	FAM10-06	FAF10-06	3/8" BSP	60	2.36	64.5	2.54	32	1.26	109	4.29	27	1.06	30	1.18
		FAM15-06	FAF15-06	3/8" NPTF												
		FAM18-06	FAF18-06	3/8" BSPT												
06	9	FAM10-08	FAF10-08	1/2" BSP	62.5	2.46	69.5	2.74	32	1.26	116.5	4.59	27	1.06	30	1.18
		FAM15-08	FAF15-08	1/2" NPTF												
		FAM18-08	FAF18-08	1/2" BSPT												
08	13	FAM20-08	FAF20-08	1/2" BSP	68	2.68	76.5	3.01	38	1.50	127.5	5.02	36	1.42	36	1.42
		FAM25-08	FAF25-08	1/2" NPTF												
		FAM28-08	FAF28-08	1/2" BSPT												
08	13	FAM10-12	FAF10-12	3/4" BSP	70.5	2.78	83.5	3.29	38	1.50	137	4.39	36	1.42	36	1.42
		FAM15-12	FAF15-12	3/4" NPTF												
		FAM18-12	FAF18-12	3/4" BSPT												
12	15	FAM20-12	FAF20-12	3/4" BSP	73	2.87	83.5	3.29	42	1.65	139.5	5.49	36	1.42	41	1.61
		FAM25-12	FAF25-12	3/4" NPTF												
		FAM28-12	FAF28-12	3/4" BSPT												
16	17	FAM10-16	FAF10-16	1" BSP	84	3.31	98.5	3.88	48	1.89	161	6.34	46	1.81	46	1.81
		FAM15-16	FAF15-16	1" NPTF												
		FAM18-16	FAF18-16	1" BSPT												
20	21	FM10-20	FAF10-20	1.1/4" BSP	90	3.54	105	4.13	55	2.17	173	6.81	55	2.17	55	2.17
		FM15-20	FAF15-20	1.1/4" NPTF												
		FM18-20	FAF18-20	1.1/4" BSPT												
24	30	FM10-24	FAF10-24	1.1/2" BSP	111	4.37	132.5	5.22	80	3.15	215	8.46	65	2.56	65	2.56
		FM15-24	FAF15-24	1.1/2" NPTF												
		FM18-24	FAF18-24	1.1/2" BSPT												

* Other threads available on request Ulteriori filettature disponibili a richiesta.

MAIN DATA

Series FA flat face couplings are dimensionally interchangeable with our F series but allow higher pressures. The FA series performances make this range the ideal solution for heavy duty mobile applications where high working pressure and peak pressures are associated to difficult environmental working conditions.

- Perfect sealing of plug and socket both when coupled and uncoupled;
- Extremely low spillage during connection and disconnection;
- No inclusion of air or external media during connection and disconnection;
- The flat faces are easy to clean;
- Sleeve with a safety device preventing from accidental disconnection;
- Standard seals in nitril rubber;
- Antiextrusion ring in teflon;
- Working temperature with standard seals: -20° / +110°C;
- Body size 3/8 (DN 9) is interchangeable according to HTMA design;
- Special seals on request: Viton, EPDM.

FPM plug is a special version allowing connection by hand with back pressure up to 200 bar. Available in sizes 1/4" to 1".

CARATTERISTICHE PRINCIPALI

Gli innesti serie FA sono un'evoluzione tecnica della serie F, della quale mantengono l'intercambiabilità dimensionale. Le soluzioni tecniche adottate permettono pressioni d'esercizio particolarmente elevate che rendono possibile l'adozione di questi innesti in applicazioni caratterizzate da piccoli pressori, forti sollecitazioni meccaniche e condizioni di lavoro esasperate.

- Tenuta totale con innesti separati e accoppiati;
- Perdite di fluido bassissime nelle fasi di accoppiamento e sgancio;
- Nessuna intrusione di agenti esterni durante le connessioni;
- Facile pulizia delle superfici di accoppiamento;
- Ghiera con sistema antigancio;
- Guarnizioni standard in gomma nitrilica;
- Anelli antiestrusione in teflon;
- Temperature d'esercizio con guarnizioni standard: -20°C / +110°C;
- Misura 3/8 (DN 9) intercambiabile secondo norme HTMA;
- Guarnizioni speciali a richiesta: Viton, EPDM;

Il maschio speciale versione FPM permette la connessione manuale in presenza di pressioni residue fino a 200 bar. Disponibile nelle dimensioni da 1/4" a 1".

PRESSURE DROP GRAPH GRAFICO PERDITE DI CARICO

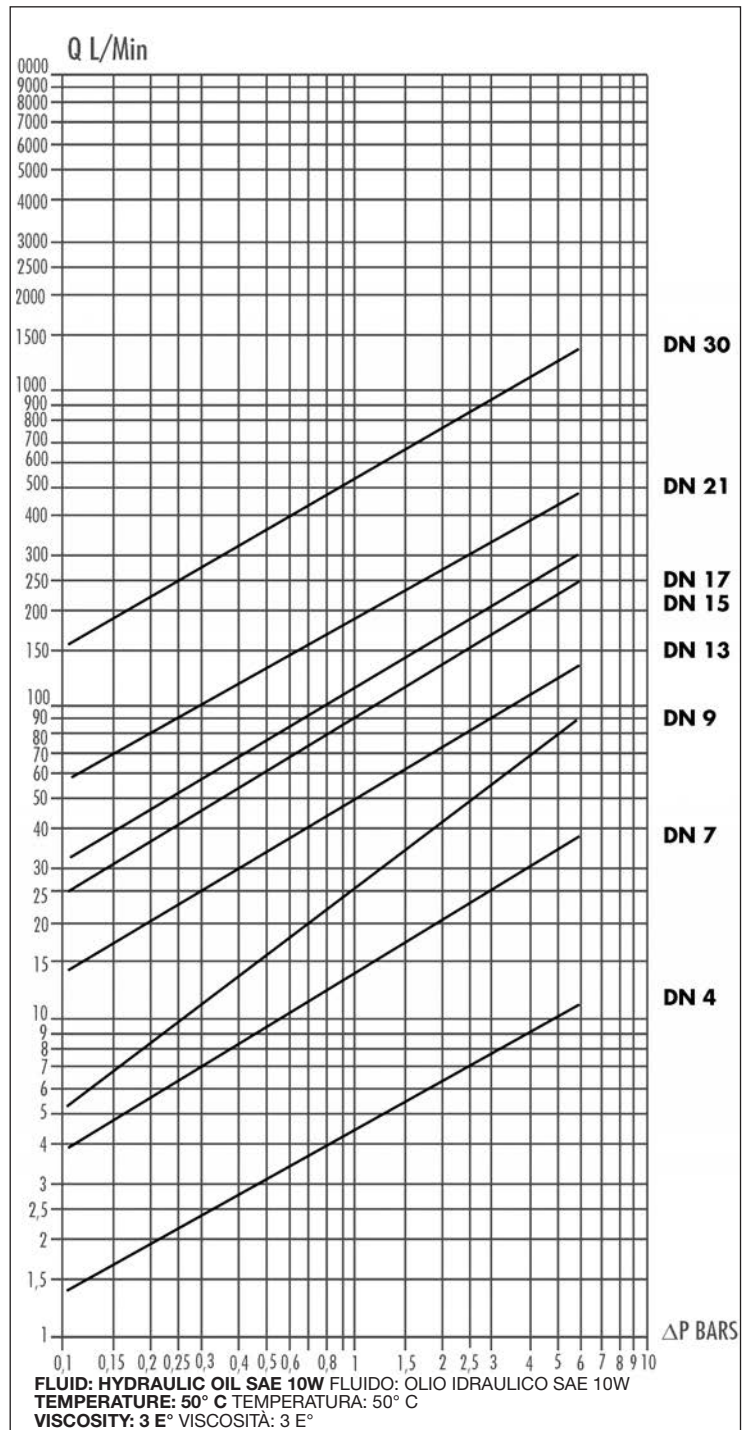

PERFORMANCES PRESTAZIONI

SIZE BASE	Ø DN	MAX WORK PRESSURE		MIN. BURST PRESSURE PRESSIONE SCOPPIO						WEIGHT PESO				FORCE TO CONNECT FORZA AGGANCIO	
				coupled accoppiato		plug maschio		socket femmina		plug maschio		socket femmina			
		mm	bar	psi	bar	psi	bar	psi	bar	psi	kg	lbs	kg	lbs	kg
02	4	400	5800	1400	20300	1600	23200	1400	20300	0.027	0.06	0.083	0.180	15	33.333
04	7	400	5800	1200	17400	1200	17400	1100	15950	0.060	0.13	0.189	0.420	17	37.778
06	9	375	5438	1100	15950	1100	15950	1100	15950	0.148	0.32	0.257	0.570	21	46.667
06	9	375	5438	1100	15950	1100	15950	1100	15950	0.148	0.32	0.272	0.604	21	46.667
08	13	350	5075	1100	15950	1100	15950	1000	14500	0.273	0.60	0.452	1.000	23	51.111
08	13	350	5075	1100	15950	1100	15950	1000	14500	0.268	0.59	0.452	1.000	23	51.111
12	15	350	5075	1100	15950	1100	15950	900	13050	0.300	0.66	0.615	1.360	18	40.000
16	17	350	5075	1100	15950	1100	15950	900	13050	0.409	0.90	0.941	2.090	22	48.889
20	21	350	5075	1100	15950	1100	15950	800	11600	0.610	1.35	1.360	3.020	35	77.778
24	30	250	3625	1000	14500	1000	14500	800	11600	1.630	3.62	3.320	7.370	44	97.778

HP series

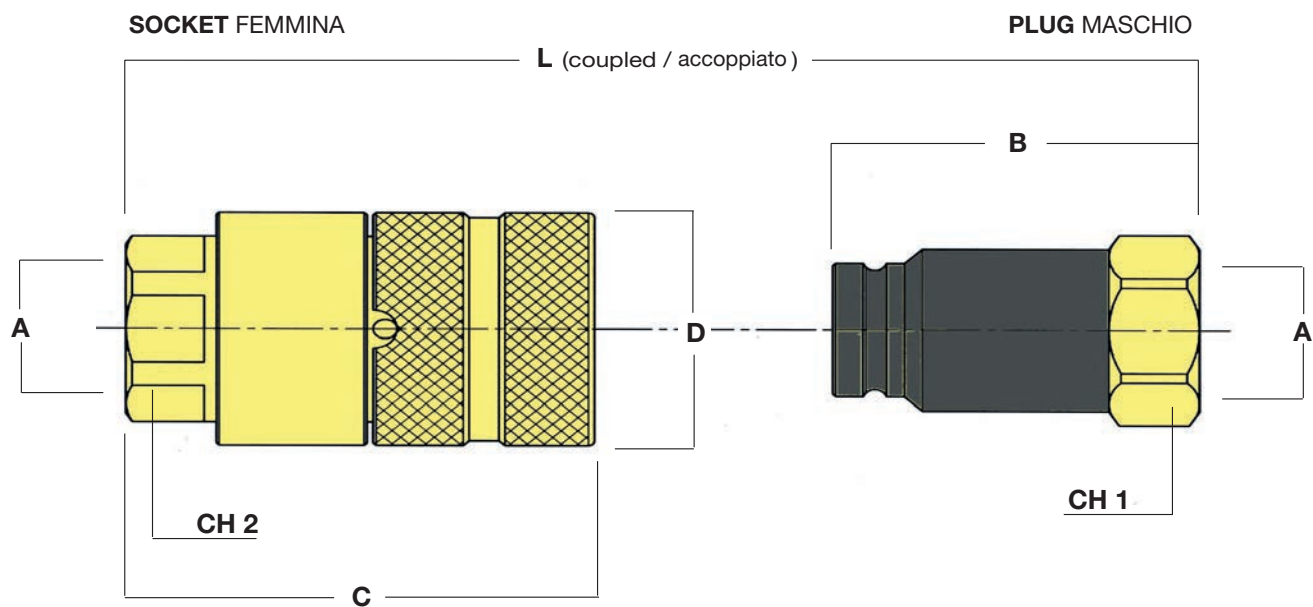

SIZE BASE	Ø DN mm	CODE CODICE		Ø A*	B		C		Ø D		L		CH 1		CH 2	
		plug maschio	socket femmina		mm	in	mm	in	mm	in	mm	in	mm	in	mm	in
04	5	HPM10-04	HPF10-04	1/4" BSP	48	1.89	58	2.28	29	1.14	95	3.74	22	0.87	22	0.87
		HPM15-04	HPF15-04	1/4" NPTF												
		HPM18-04	HPF18-04	1/4" BSPT												
04	5	HPM10-06	HPF10-06	3/8" BSP	50	1.97	60	2.36	29	1.14	99	3.90	24	0.94	24	0.94
		HPM15-06	HPF15-06	3/8" NPTF												
		HPM18-06	HPF18-06	3/8" BSPT												
06	8	HPM20-06	HPF20-06	3/8" BSP	61	2.40	70	2.76	34	1.34	114	4.49	27	1.06	30	1.18
		HPM25-06	HPF25-06	3/8" NPTF												
		HPM28-06	HPF28-06	3/8" BSPT												
06	8	HPM10-08	HPF10-08	1/2" BSP	63	2.48	76	2.99	34	1.34	122	4.80	27	1.06	30	1.18
		HPM15-08	HPF15-08	1/2" NPTF												
		HPM18-08	HPF18-08	1/2" BSPT												

* Other threads available on request Ulteriori filettature disponibili a richiesta.

MAIN DATA

Series HP include flat face couplings designed for the very high pressures typical of the hydraulic tools and power-packs (720 bar/10.000 psi).

- Perfect sealing of plug and socket both when coupled and uncoupled;
- Extremely low spillage during connection and disconnection;
- No inclusion of air or external media during connection and disconnection;
- The flat faces are easy to clean;
- Sleeve with a safety device preventing from accidental disconnection;
- Standard seals in nitril rubber;
- Antiextrusion ring in teflon;
- Working temperature with standard seals: -20°C / +110°C;
- Special seals on request.

CARATTERISTICHE PRINCIPALI

La serie HP comprende gli innesti a facce piane sviluppati per altissime pressioni (fino a 720 bar). Questi innesti vengono tipicamente utilizzati per utensili e centraline idrauliche.

- Tenuta totale con innesti separati e accoppiati;
- Perdite di fluido bassissime nelle fasi di accoppiamento e sgancio;
- Nessuna intrusione di agenti esterni durante le connessioni;
- Facile pulizia delle superfici di accoppiamento;
- Ghiera con sistema antisgancio;
- Guarnizioni standard in gomma nitrilica;
- Anelli antiestrusione in teflon;
- Temperature d'esercizio con guarnizioni standard: -20°C / +110°C;
- Guarnizioni speciali a richiesta;

PRESSURE DROP GRAPH GRAFICO PERDITE DI CARICO

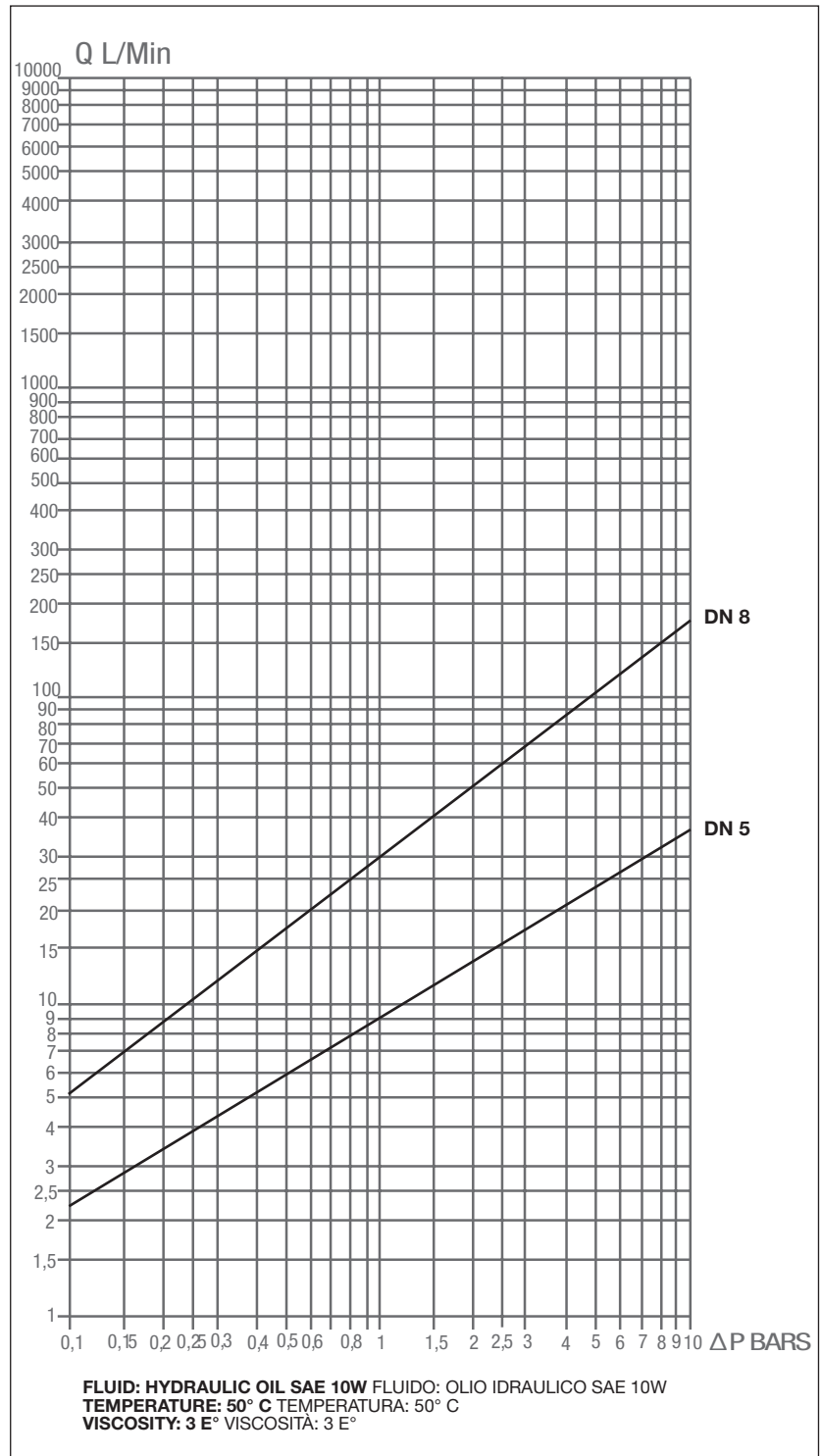

PERFORMANCES PRESTAZIONI

SIZE BASE	Ø DN	MAX WORK PRESSURE		MIN. BURST PRESSURE PRESSIONE SCOPPIO						WEIGHT PESO				FORCE TO CONNECT FORZA AGGANCIAMENTO	
				coupled accoppiato		plug maschio		socket femmina		plug maschio		socket femmina			
				bar	psi	bar	psi	bar	psi	bar	psi	kg	lbs		
04	5	720	10440	1800	26100	2000	29000	1800	26100	0.075	0.166	0.225	0.500	15	33.33
04	5	720	10440	1800	26100	2000	29000	1800	26100	0.080	0.177	0.240	0.530	15	33.33
06	8	720	10440	1800	21750	2000	29000	1500	21750	0.115	0.255	0.345	0.766	16	35.56
06	8	720	10440	1800	21750	2000	29000	1500	21750	0.120	0.266	0.360	0.800	16	35.56

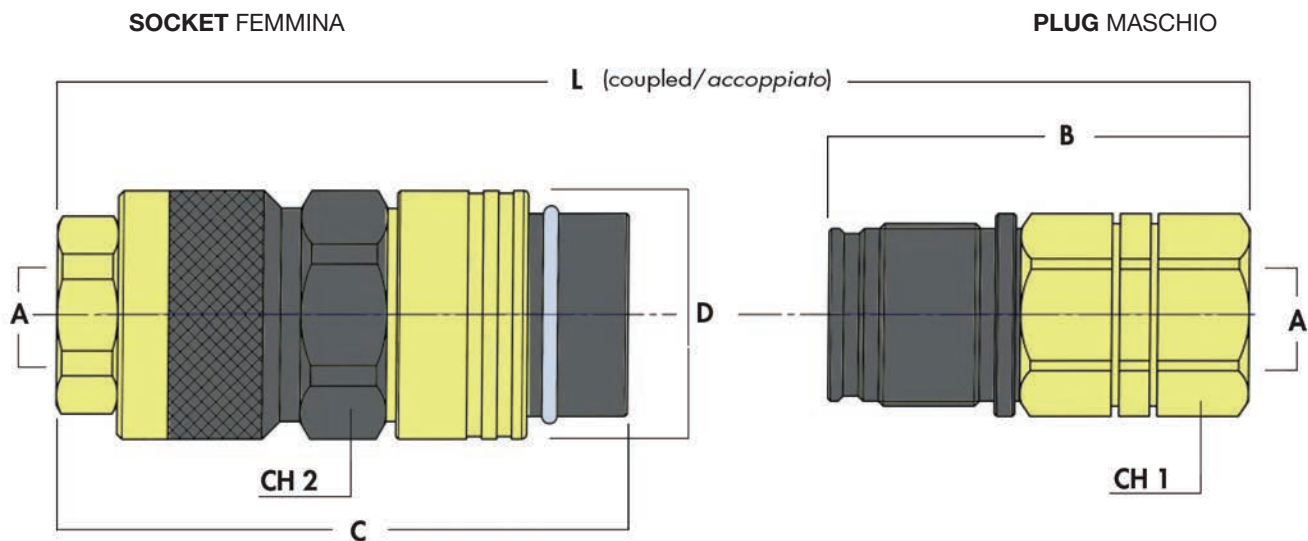

SIZE BASE	Ø DN mm	CODE CODICE		Ø A*	B		C		Ø D		L		M	CH 1		CH 2	
		plug maschio	socket femmina		mm	in	mm	in	mm	in	mm	in		mm	in	mm	in
04	7	VPM10-04	VPF10-04	1/4" BSP	53.0	2.09	84	3.31	35	1.38	125.5	4.94	M24x2	27	1.06	32	1.26
		VPM15-04	VPF15-04	1/4" NPTF													
		VPM18-04	VPF18-04	1/4" BSPT													
06	9	VPM10-06	VPF10-06	3/8" BSP	64.5	2.54	94.5	3.72	42	1.65	142.5	5.61	M28x2	30	1.18	38	1.50
		VPM15-06	VPF15-06	3/8" NPTF													
		VPM18-06	VPF18-06	3/8" BSPT													
06	9	VPM10-08	VPF10-08	1/2" BSP	69.5	2.74	94.5	3.72	42	1.65	147.5	5.81	M28x2	30	1.18	38	1.50
		VPM15-08	VPF15-08	1/2" NPTF													
		VPM18-08	VPF18-08	1/2" BSPT													
08	13	VPM20-08	VPF20-08	1/2" BSP	76.5	3.01	110	4.33	49	1.93	168	6.61	M36x3	36	1.42	45	1.77
		VPM25-08	VPF25-08	1/2" NPTF													
		VPM28-08	VPF28-08	1/2" BSPT													
08	13	VPM10-12	VPF10-12	3/4" BSP	83.5	3.29	110	4.33	49	1.93	175	6.89	M36x3	36	1.42	45	1.77
		VPM15-12	VPF15-12	3/4" NPTF													
		VPM18-12	VPF18-12	3/4" BSPT													
12	15	VPM20-12	VPF20-12	3/4" BSP	83.5	3.29	110	4.33	52	2.05	175	6.89	M39x3	41	1.61	48	1.89
		VPM25-12	VPF25-12	3/4" NPTF													
		VPM28-12	VPF28-12	3/4" BSPT													
16	17	VPM10-16	VPF10-16	1" BSP	98	3.86	127	5.00	60	2.36	202.5	7.97	M45x3	46	1.81	55	2.17
		VPM15-16	VPF15-16	1" NPTF													
		VPM18-16	VPF18-16	1" BSPT													
20	21	VPM10-20	VPF10-20	1.1/4" BSP	105	4.13	137	5.39	76	2.99	215	8.46	M55x3	55	2.17	70	2.76
		VPM15-20	VPF15-20	1.1/4" NPTF													
		VPM18-20	VPF18-20	1.1/4" BSPT													
24	30	VPM10-24	VPF10-24	1.1/2" BSP	132.5	5.22	175	6.89	94	3.70	271	10.70	M72x4	65	2.56	85	3.35
		VPM15-24	VPF15-24	1.1/2" NPTF													
		VPM18-24	VPF18-24	1.1/2" BSPT													

* Other threads available on request Ulteriori filettature disponibili a richiesta.

MAIN DATA

The VP series represents the ideal combination of flate face and screw to connect designs. This range achieves very high working pressures and is suitable for heavy duty working conditions such as pulsating pressures and vibrations (up to 300 bar/4300 psi).

VP series offers the important possibility of connecting and disconnecting the two parts under pressure with no spillage (up to 300bar/4300psi).

- Perfect sealing of plug and socket both when coupled and uncoupled;
- Extremely low spillage during connection and disconnection;
- No inclusion of air or external media during connection and disconnection;
- The flat faces are easy to clean;
- Sleeve with a safety device preventing from accidental disconnection;
- Standard seals in nitril rubber;
- Antiextrusion ring in teflon;
- Working temperature with standard seals: -20°C / +110°C;
- Special seals on request: Viton, EPDM, Neoprene, Silicone;
- Special caps on request;

CARATTERISTICHE PRINCIPALI

La serie VP rappresenta l'ideale combinazione tra il concetto di innesto a facce piane e quello a vite. Il risultato è un innesto dalle prestazioni eccezionali capace di resistere alle più difficili condizioni d'impiego come pressioni pulsanti ed elevate vibrazioni.

Particolarmente importante è la possibilità di connessione e sgancio in presenza di pressioni residue fino a 300 bar.

- Tenuta totale con innesti separati e accoppiati;
- Perdite di fluido bassissime nelle fasi di accoppiamento e sgancio;
- Nessuna intrusione di agenti esterni durante le connessioni;
- Facile pulizia delle superfici di accoppiamento;
- Ghiera con sistema anti-sgancio;
- Guarnizioni standard in gomma nitrilica;
- Anelli antiestrusione in teflon;
- Temperature d'esercizio con guarnizioni standard: -20°C/+110°C;
- Guarnizioni speciali a richiesta: Viton, EPDM, Neoprene, Silicone.
- Tappi speciali a richiesta.

PRESSURE DROP GRAPH GRAFICO PERDITE DI CARICO

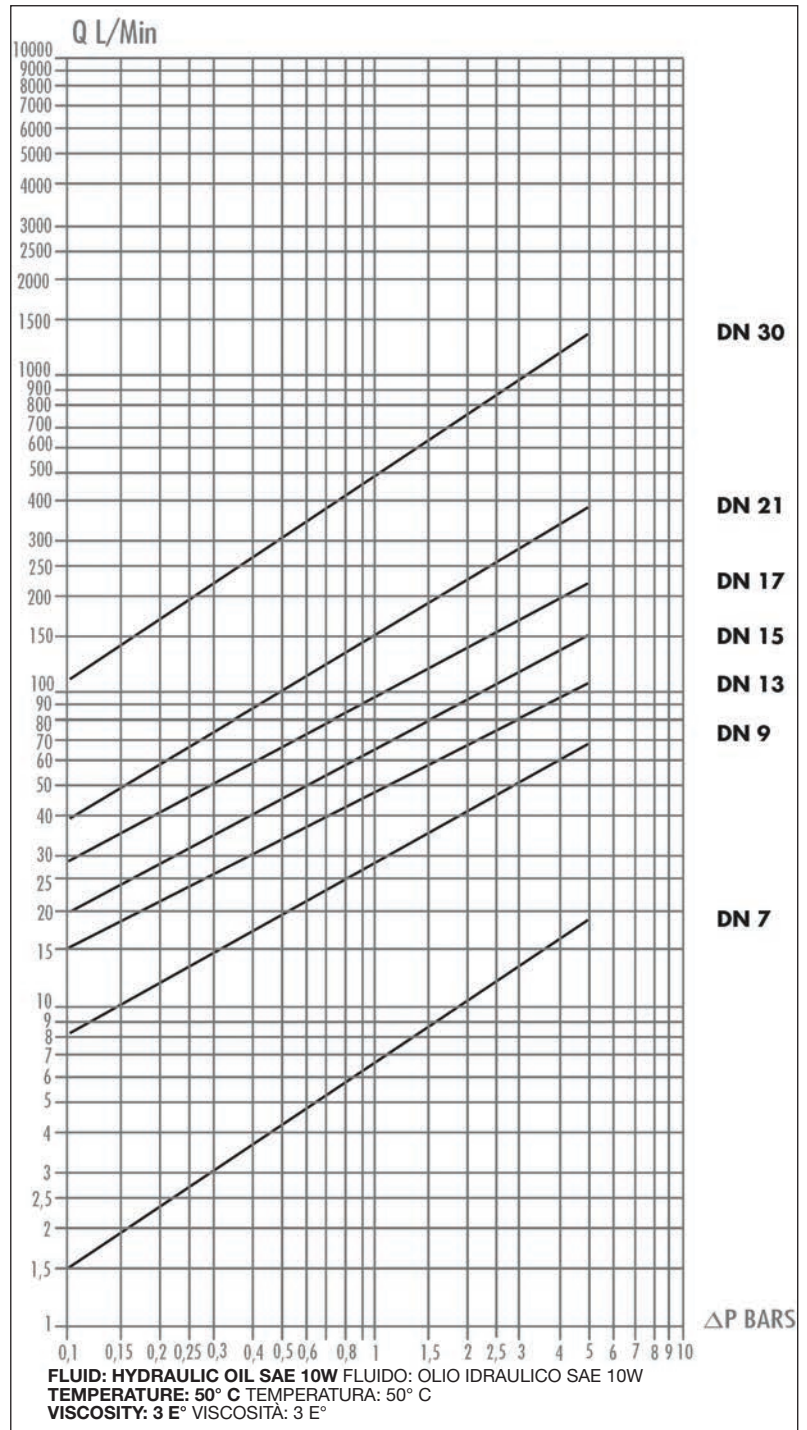

PERFORMANCES PRESTAZIONI

SIZE BASE	Ø DN mm	MAX WORK PRESSURE MAX PRESS. D'ESERCIZIO		MIN. BURST PRESSURE PRESSIONE SCOPPIO						WEIGHT PESO			
		bar	psi	coupled accoppiato		plug maschio		socket femmina		plug maschio		socket femmina	
				bar	psi	bar	psi	bar	psi	bar	psi	kg	lbs
04	7	600	8700	1500	21750	1800	26100	1250	18125	0.16	0.35	0.45	1.00
06	9	550	7975	1350	19575	1500	21750	1250	18125	0.21	0.46	0.63	1.40
06	9	550	7975	1350	19575	1500	21750	1250	18125	0.21	0.46	0.60	1.33
08	13	550	7975	1350	19575	1700	24650	1100	15950	0.33	0.73	0.96	2.13
08	13	550	7975	1350	19575	1700	24650	1100	15950	0.33	0.73	0.96	2.13
12	15	525	7612.5	1350	19575	1600	23200	1000	14500	0.42	0.93	1.26	2.80
16	17	525	7612.5	1350	19575	1500	21750	1000	14500	0.62	1.37	1.83	4.06
20	21	500	7250	1250	18125	1200	17400	900	13050	0.96	2.13	2.90	6.44
24	30	400	5800	1000	14500	1000	14500	900	13050	2.10	4.60	6.30	14.00

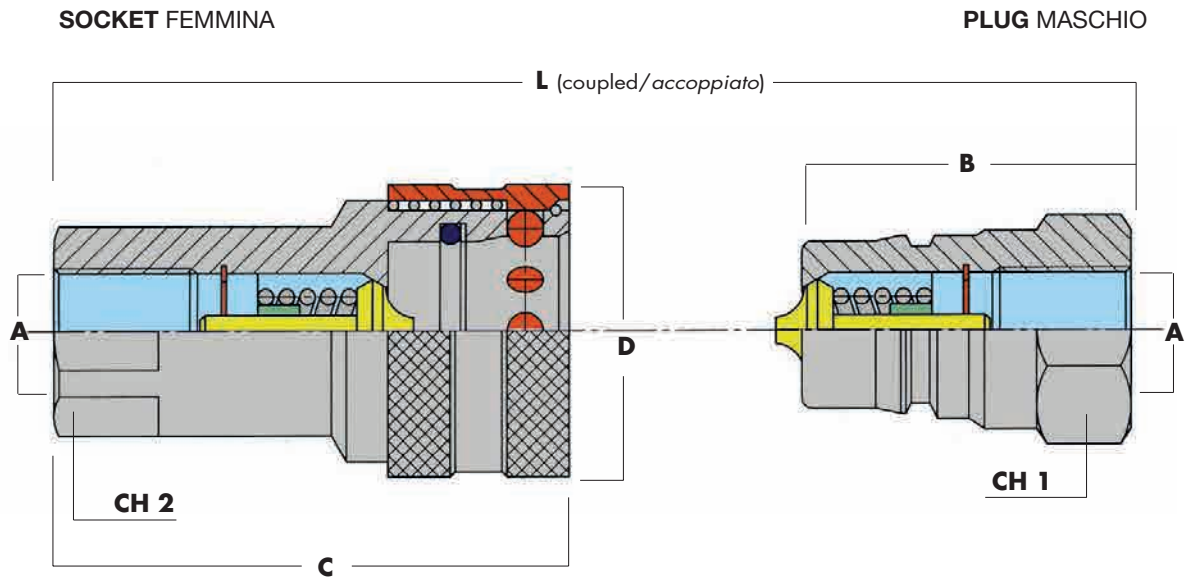

SIZE BASE	Ø DN		CODE CODICE		Ø A*	B		C		Ø D		L		CH 1		CH 2	
	mm	in	plug maschio	socket femmina		mm	in	mm	in	mm	in	mm	in	mm	in	mm	in
02	5,0	1/8"	XM10-02	XF10-02	1/8"BSP	30	1.18	49	1.93	24	0.94	60.5	2.38	14	0.55	14	0.55
			XM15-02	XF15-02	1/8"NPTF												
04	6,3	1/4"	XM10-04	XF10-04	1/4"BSP	35	1.38	57	2.24	27	1.06	70.5	2.78	19	0.75	19	0.75
			XM15-04	XF15-04	1/4"NPTF												
06	10,0	3/8"	XM10-06	XF10-06	3/8"BSP	41	1.61	66	2.60	34	1.34	82.5	3.25	24	0.94	24	0.94
			XM15-06	XF15-06	3/8"NPTF												
08	12,5	1/2"	XM10-08	XF10-08	1/2"BSP	46	1.81	74	2.91	42	1.65	92.5	3.64	27	1.06	27	1.06
			XM15-08	XF15-08	1/2"NPTF												
12	20,0	3/4"	XM10-12	XF10-12	3/4"BSP	55	2.17	90	3.54	50	1.97	111	4.37	36	1.42	36	1.42
			XM15-12	XF15-12	3/4"NPTF												
16	25,0	1"	XM10-16	XF10-16	1"BSP	66	2.60	106	4.17	60	2.36	133	5.24	41	1.61	41	1.61
			XM15-16	XF15-16	1"NPTF												

* Other threads available on request Ulteriori filettature disponibili a richiesta.

MAIN DATA

Series X made in AISI 316 stainless steel and is interchangeable according to ISO 7241-B design.

This series finds application with water or corrosive media and in corrosive environments.

- Interchangeability according to ISO 7241-B;
- Material: AISI 316 stainless steel;
- Internal valves and components in AISI 316;
- Standard seals in Viton;
- Working temperature range with standard Viton seals: -15°C / +180°C;
- Special seals on request;

CARATTERISTICHE PRINCIPALI

La serie X è costruita in acciaio inox AISI 316 ed è dimensionalmente intercambiabile secondo la normativa ISO 7241-B.

Questa serie trova applicazione ideale in situazioni ambientali corrosive o con fluidi particolari quali acqua, alimentari, acidi, etc.

- Intercambiabilità secondo ISO 7241-B;
- Materiale: acciaio inox AISI 316;
- Valvole e componenti interni in AISI 316;
- Guarnizioni standard in Viton;
- Temperature d'esercizio con guarnizioni standard: -15°C / +180°C;
- Guarnizioni speciali a richiesta;

PRESSURE DROP GRAPH GRAFICO PERDITE DI CARICO

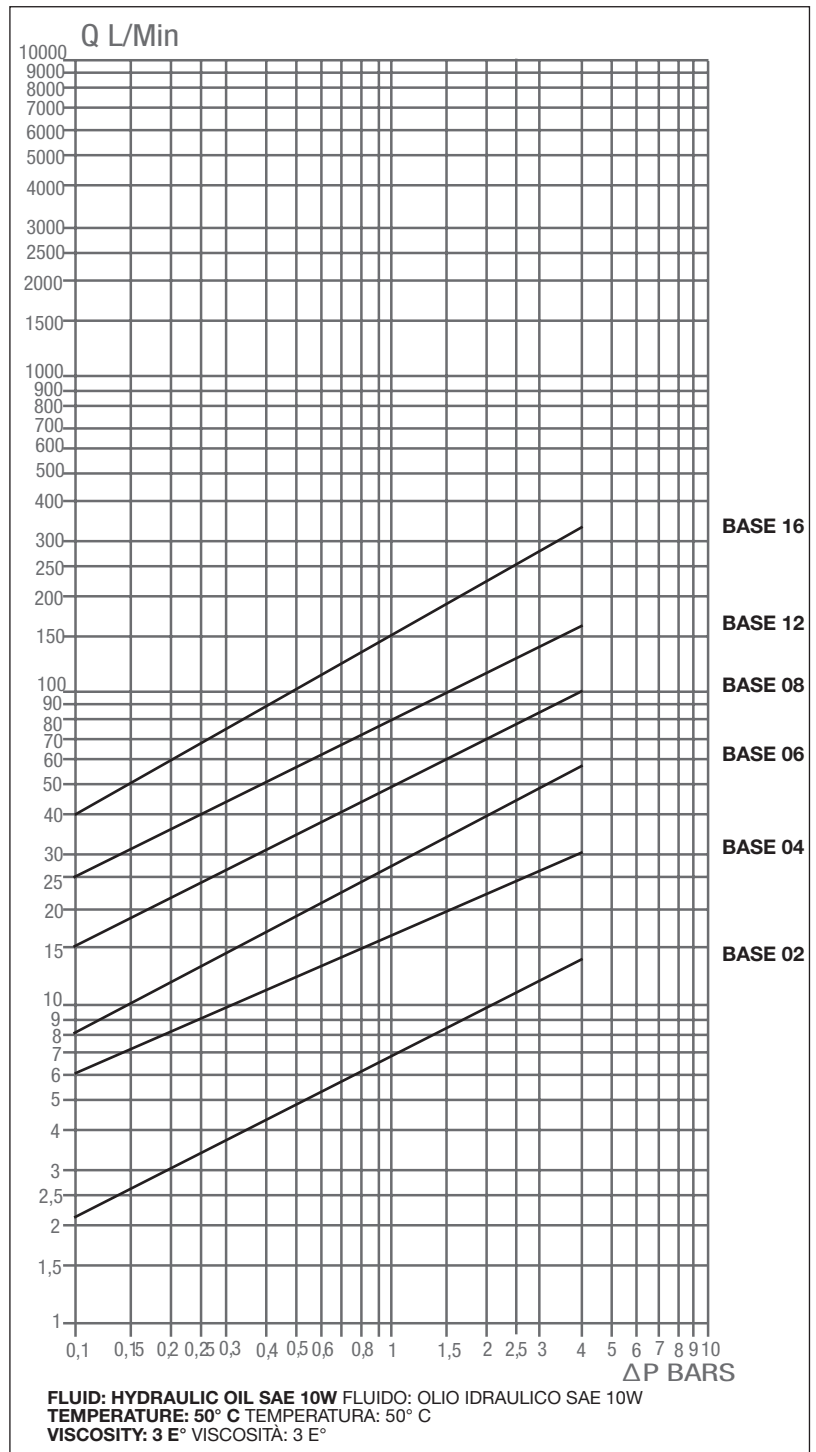

PERFORMANCES PRESTAZIONI

SIZE BASE	Ø DN		MAX WORK PRESSURE MAX PRESS. D'ESERCIZIO		BURST PRESSURE PRESSIONE SCOPPIO		WEIGHT PESO			
	mm	inch	bar	psi	bar	psi	plug maschio		socket femmina	
							kg	lbs	kg	lbs
02	5.0	1/8"	150	2175.0	600	8700	0.020	0.044	0.070	0.156
04	6.3	1/4"	150	2175.0	600	8700	0.040	0.080	0.120	0.260
06	10.0	3/8"	100	1450.0	400	5800	0.070	0.156	0.220	0.489
08	12.5	1/2"	100	1450.0	400	5800	0.102	0.227	0.322	0.716
12	20.0	3/4"	100	1450.0	400	5800	0.195	0.430	0.585	1.300
16	25.0	1"	75	1087.0	300	4350	0.370	0.820	0.860	1.911

SOCKET FEMMINA

PLUG MASCHIO

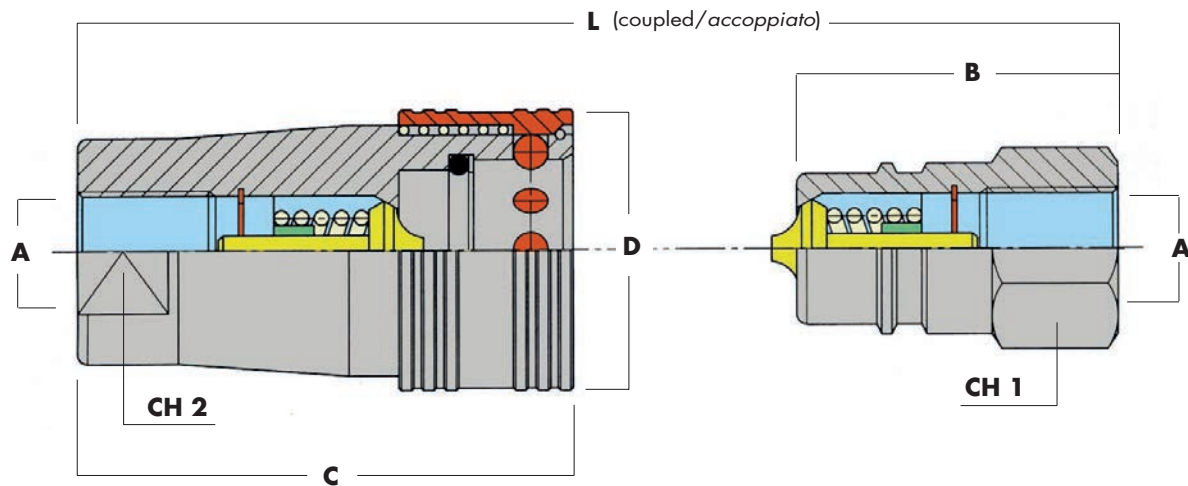

SIZE BASE	Ø DN		CODE CODICE		Ø A*	B		C		Ø D		L		CH 1		CH 2	
	mm	in	plug maschio	socket femmina		mm	in	mm	in	mm	in	mm	in	mm	in	mm	in
20	32	1.1/4"	RM10-20	RF10-20	1.1/4" BSP	70	2.76	110	4.33	70	2.75	140	5.51	50	1.97	50	1.97
			RM15-20	RF15-20	1.1/4" NPTF												
			RM18-20	RF18-20	1.1/4" NPTF												
24	38	1.1/2"	RM10-24	RF10-24	1.1/2" BSP	70	2.76	114	4.49	81	3.18	140	5.51	60	2.36	55	2.17
			RM15-24	RF15-24	1.1/2" NPTF												
			RM18-24	RF18-24	1.1/2" BSPT												
32	50	2"	RM10-32	RF10-32	2" BSP	89	3.50	139	5.47	113	4.45	177	6.97	70	2.76	70	2.76
			RM15-32	RF15-32	2" NPTF												
			RM18-32	RF18-32	2" BSPT												
40	63	2.1/2"	RM10-40	RF10-40	2.1/2" BSP	89	3.50	139	5.47	113	4.45	177	6.97	84	3.30	84	3.30
			RM15-40	RF15-40	2.1/2" NPTF												
			RM18-40	RF18-40	2.1/2" NPTF												
50	76	3"	RM10-50	RF10-50	3" BSP	100	3.94	155	6.10	139	5.47	200	7.87	100	3.94	100	3.94
			RM15-50	RF15-50	3" NPTF												
			RM18-50	RF18-50	3" BSPT												

* Other threads available on request Ulteriori filettature disponibili a richiesta.

MAIN DATA

Series R includes large bore quick disconnect couplings (1.1/4" to 3") made in AISI 316 stainless steel. This series is ideal in industrial applications with water or corrosive media.

- Material: AISI 316 stainless steel;
- Internal valves and components in AISI 316;
- Standard seals in Viton;
- Working temperature range with standard Viton seals: -15°C / +180°C;
- Special seals on request;
- Free flow version on request.

CARATTERISTICHE PRINCIPALI

La serie R è costituita da innesti di grosso diametro (1.1/4 - 3") costruiti in acciaio inox ASI 316. Questi innesti trovano applicazione ideale nell'impiantistica industriale in presenza di fluidi corrosivi.

- Materiale: acciaio inox AISI 316;
- Valvole e componenti interni in AISI 316;
- Guarnizioni standard in Viton;
- Temperature d'esercizio con guarnizioni standard: -15°C / +180°C
- A richiesta guarnizioni speciali e versioni a passaggio libero.

PRESSURE DROP GRAPH GRAFICO PERDITE DI CARICO

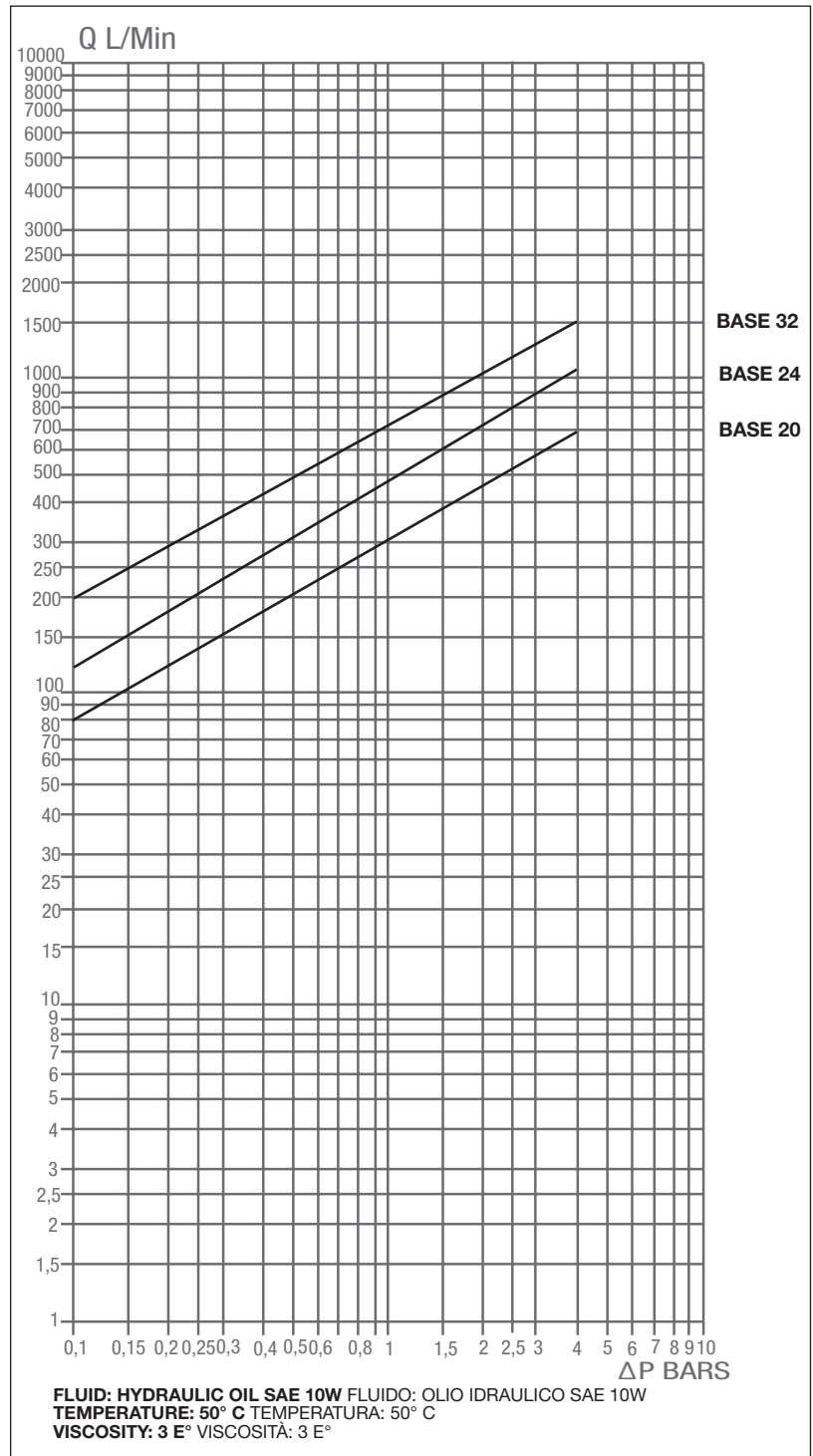

PERFORMANCES PRESTAZIONI

SIZE BASE	Ø DN		MAX WORK PRESSURE MAX PRESS. D'ESERCIZIO		BURST PRESSURE PRESSIONE SCOPPIO		WEIGHT PESO			
	mm	inch	bar	psi	bar	psi	plug maschio		socket femmina	
							kg	lbs	kg	lbs
20	32	1.1/4"	50	725	200	2900	0.460	1.022	1.38	3.070
24	38	1.1/2"	40	580	160	2320	0.720	1.600	1.82	4.040
32	50	2"	30	435	120	1740	2.020	4.489	4.42	9.820
40	63	2.1/2"	20	290	80	1160	1.820	4.040	4.05	9.000
50	76	3"	20	290	80	1160	3.230	7.170	7.00	15.500

Z series

SOCKET FEMMINA

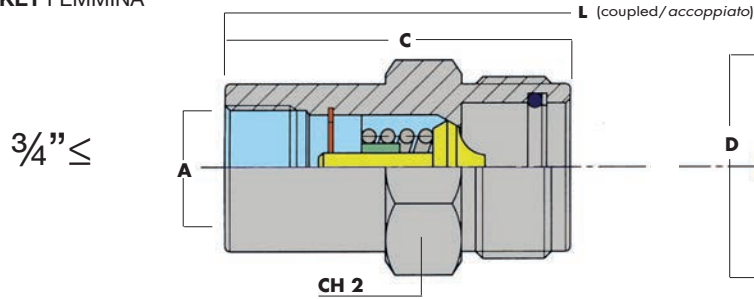

$3/4'' \leq$

PLUG MASCHIO

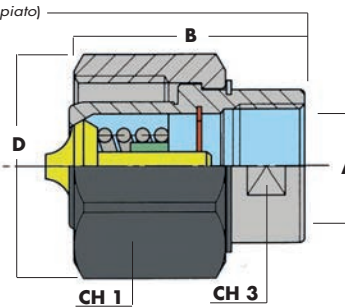

SOCKET FEMMINA

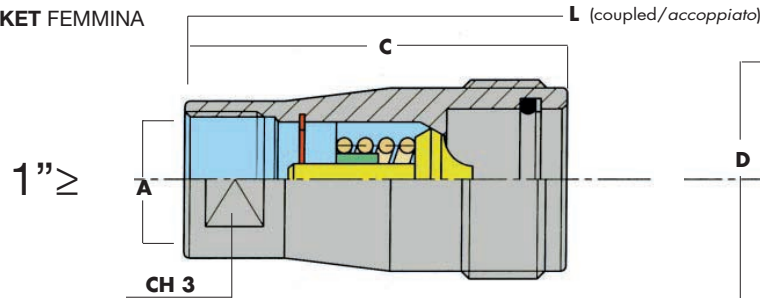

$1'' \geq$

PLUG MASCHIO

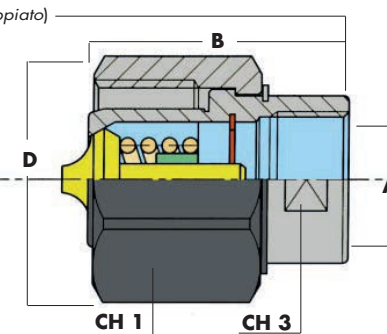

SIZE BASE	Ø DN		CODE CODICE		Ø A*	B		C		Ø D		L		CH 1		CH 2		CH 3	
	mm	in	plug maschio	socket femmina		mm	in	mm	in	mm	in	mm	in	mm	in	mm	in	mm	in
04	6	1/4"	ZM10-04	ZF10-04	1/4"BSP	36	1.42	50	1.97	31	1.22	69	2.72	28	1.10	24	0.94	16	0.63
			ZM15-04	ZF15-04	1/4"NPTF														
			ZM18-04	ZF18-04	1/4" NPTF														
06	10	3/8"	ZM10-06	ZF10-06	3/8"BSP	42	1.65	57	2.24	38	1.5	82	3.23	34	1.34	30	1.18	20	0.79
			ZM15-06	ZF15-06	3/8"NPTF														
			ZM18-06	ZF18-06	3/8" BSPT														
08	12	1/2"	ZM10-08	ZF10-08	1/2"BSP	55	2.17	75	2.95	47	1.85	100	3.94	42	1.65	38	1.50	27	1.06
			ZM15-08	ZF15-08	1/2"NPTF														
			ZM18-08	ZF18-08	1/2"BSPT														
12	20	3/4"	ZM10-12	ZF10-12	3/4"BSP	61	2.40	90	3.54	56	2.2	114	4.49	50	1.97	42	1.65	30	1.18
			ZM15-12	ZF15-12	3/4"NPTF														
			ZM18-12	ZF18-12	3/4" NPTF														
16	25	1"	ZM10-16	ZF10-16	1"BSP	61	2.40	88	3.46	67	2.64	120	4.72	60	2.36	-	-	40	1.57
			ZM15-16	ZF15-16	1"NPTF														
			ZM18-16	ZF18-16	1"BSPT														
20	32	1.1/4"	ZM10-20	ZF10-20	1.1/4"BSP	70	2.76	105	4.13	79	3.11	140	5.51	70	2.76	-	-	48	1.89
			ZM15-20	ZF15-20	1.1/4"NPTF														
			ZM18-20	ZF18-20	1.1/4" NPTF														
24	38	1.1/2"	ZM10-24	ZF10-24	1.1/2"BSP	70	2.76	105	4.13	90	3.54	140	5.51	80	3.15	-	-	52	2.05
			ZM15-24	ZF15-24	1.1/2"NPTF														
			ZM18-24	ZF18-24	1.1/2"BSPT														
32	50	2"	ZM10-32	ZF10-32	2"BSP	86	3.39	130	5.12	128	5.04	173	6.81	120	4.72	-	-	80	3.15
			ZM15-32	ZF15-32	2"NPTF														
			ZM18-32	ZF18-32	2" NPTF														
40	63	2.1/2"	ZM10-40	ZF10-40	2.1/2"BSP	86	3.39	130	5.12	128	5.04	173	6.81	120	4.72	-	-	85	3.35
			ZM15-40	ZF15-40	2.1/2"NPTF														
			ZM18-40	ZF18-40	2.1/2"BSPT														

* Other threads available on request Ulteriori filettature disponibili a richiesta.

MAIN DATA

Series Z is a screw to connect coupling range made in stainless steel AISI 316 and available in sizes from 1/4" to 2.1/2". This series is adapted for high pressure applications working with either corrosive media or in corrosive environmental conditions.

- Standard material: AISI 316 stainless steel;
- Internal valves and components in AISI 316;
- Locking sleeve in AISI 316 treated with Q.P.Q.
- Standard seals in nitril rubber;
- Working temperature: -20°C +110°C;
- Special seals on request: Viton, EPDM, Neoprene.

CARATTERISTICHE PRINCIPALI

La serie Z è una gamma di innesti a vite costruita in acciaio inox AISI 316 e disponibile nelle dimensioni da 1/4" a 2.1/2".

Questa serie viene tipicamente utilizzata in applicazioni dove elevate pressioni di esercizio sono abbinate a situazioni ambientali corrosive o all'impiego di fluidi corrosivi.

- Materiale: acciaio inox AISI 316;
- Valvole e componenti interni in AISI 316;
- Ghiera di bloccaggio in AISI 316 trattato al Q.P.Q.;
- Guarnizioni in gomma nitrilica;
- Temperature d'esercizio con guarnizioni standard: -20°C / +110°C
- Guarnizioni speciali a richiesta: Viton, EPDM, Neoprene.

PRESSURE DROP GRAPH GRAFICO PERDITE DI CARICO

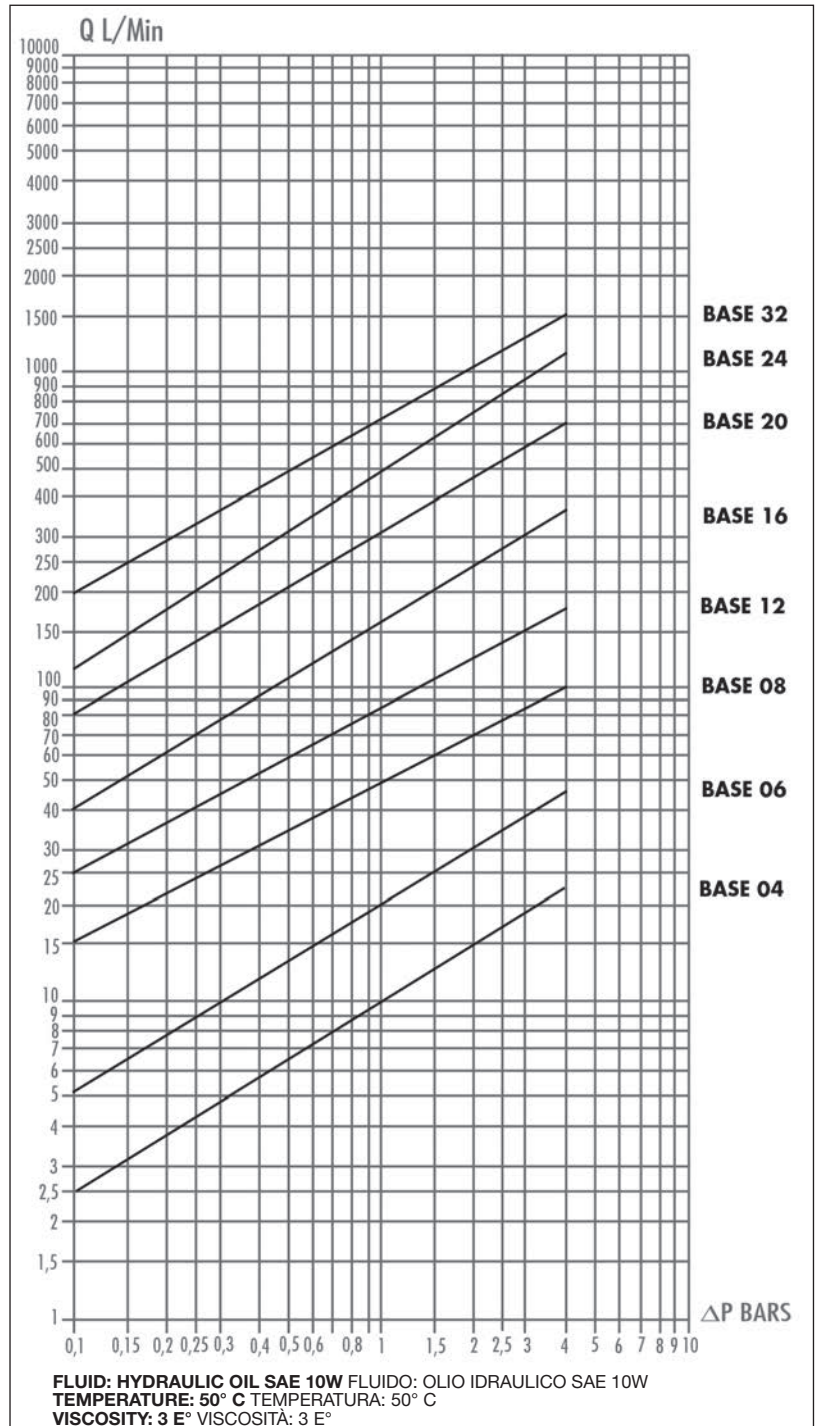

PERFORMANCES PRESTAZIONI

SIZE BASE	Ø DN		MAX WORK PRESSURE MAX PRESS. D'ESERCIZIO		BURST PRESSURE PRESSIONE SCOPPIO		WEIGHT PESO			
	mm	inch	bar	psi	bar	psi	plug maschio		socket femmina	
							kg	lbs	kg	lbs
04	6	1/4"	500	7250	2000	29000	0.080	0.180	0.100	0.220
06	10	3/8"	450	6525	1800	26100	0.150	0.330	0.180	0.400
08	12	1/2"	400	5800	1600	23200	0.260	0.580	0.392	0.870
12	20	3/4"	350	5075	1400	20300	0.370	0.830	0.550	1.210
16	25	1"	300	4350	1200	17400	0.660	1.467	0.700	1.556
20	32	1.1/4"	250	3625	1000	14500	1.000	2.220	1.030	2.290
24	38	1.1/2"	220	3190	880	12760	1.350	3.000	1.200	2.670
32	50	2"	150	2175	600	8700	4.100	9.111	3.630	8.067
40	63	2.1/2"	120	1740	480	6960	3.640	8.080	3.300	7.330

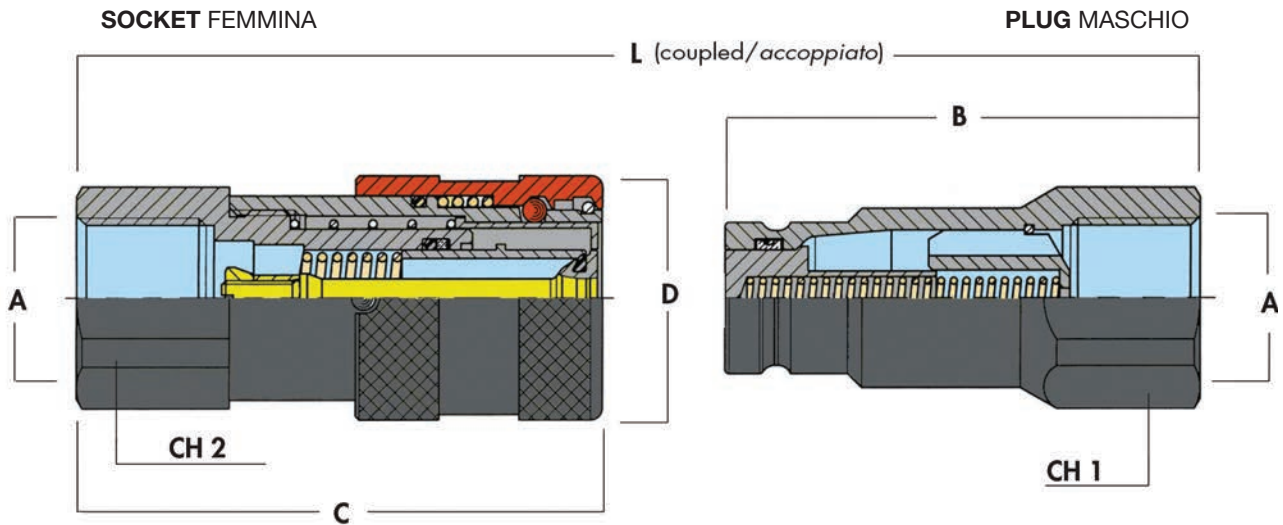

SIZE BASE	Ø DN mm	CODE CODICE		Ø A*	B		C		Ø D		L		CH 1		CH 2	
		plug maschio	socket femmina		mm	in	mm	in	mm	in	mm	in	mm	in	mm	in
04	7	QM10-04	QF10-04	1/4" BSP	48.0	1.89	48.0	1.89	28	1.10	85.5	3.37	22	0.87	22	0.87
		QM15-04	QF15-04	1/4" NPTF												
		QM18-04	QF18-04	1/4" BSPT												
06	9	QM10-06	QF10-06	3/8" BSP	60.0	2.36	64.5	2.54	32	1.26	109	4.29	24	0.94	27	1.06
		QM15-06	QF15-06	3/8" NPTF												
		QM18-06	QF18-06	3/8" BSPT												
06	9	QM10-08	QF10-08	1/2" BSP	62.5	2.46	69.5	2.74	32	1.26	117	4.59	27	1.06	27	1.06
		QM15-08	QF15-08	1/2" NPTF												
		QM18-08	QF18-08	1/2" BSPT												
08	13	QM20-08	QF20-08	1/2" BSP	68.0	2.68	73.5	2.89	38	1.50	125	4.92	32	1.26	32	1.26
		QM25-08	QF25-08	1/2" NPTF												
		QM28-08	QF28-08	1/2" BSPT												
08	13	QM10-12	QF10-12	3/4" BSP	70.5	2.78	80.5	3.17	38	1.50	135	5.30	36	1.42	36	1.42
		QM15-12	QF15-12	3/4" NPTF												
		QM18-12	QF18-12	3/4" BSPT												
12	15	QM20-12	QF20-12	3/4" BSP	70.5	2.78	78.0	3.07	42	1.65	132	5.20	36	1.42	36	1.42
		QM25-12	QF25-12	3/4" NPTF												
		QM28-12	QF28-12	3/4" BSPT												
16	17	QM10-16	QF10-16	1" BSP	82.5	3.25	92.5	3.64	48	1.89	154	6.06	45	1.77	45	1.77
		QM15-16	QF15-16	1" NPTF												
		QM18-16	QF18-16	1" BSPT												
20	21	QM10-20	QF10-20	1.1/4" BSP	90.0	3.54	105	4.13	55	2.17	173	6.81	55	2.17	55	2.17
		QM15-20	QF15-20	1.1/4" NPTF												
		QM18-20	QF18-20	1.1/4" BSPT												
24	30	QM10-24	QF10-24	1.1/2" BSP	111.0	4.37	133	5.22	80	3.15	215	8.46	70	2.76	65	2.56
		QM15-24	QF15-24	1.1/2" NPTF												
		QM18-24	QF18-24	1.1/2" BSPT												
32	45	QM10-32	QF10-32	2" BSP	125.0	4.92	165	6.50	100	3.94	250	9.84	75	2.95	80	3.15
		QM15-32	QF15-32	2" NPTF												
		QM18-32	QF18-32	2" BSPT												

* Other threads available on request Ulteriori filettature disponibili a richiesta.

MAIN DATA

Series Q flat face couplings are innovative product which finds ideal application in medium corrosive environmental conditions. The Q series is a special version of F serie where the carbon steel components are treated with QPQ. In situations where the traditional surface treatments do not allow an acceptable performance but stainless steel can not be adopted, series Q offers an excellent performance/price relation together with all the advantages linked to the flat face design. Typical applications are: insecticides, diathermic oils, air conditioning fluids, water, etc.

- Material: carbon steel QPQ treated;
- Internal valves in austenitic stainless steel;
- Springs in AISI 302, balls in AISI 420;
- Perfect sealing of plug and socket both when coupled and uncoupled;
- Extremely low spillage during connection and disconnection.
- No inclusion of air external media during connection and disconnection;
- The flat faces are easy to clean;
- Sleeve with a safety device preventing from accidental disconnection;
- Increased resistance to abrasion and corrosion;
- Size 3/8 (DN 9) interchangeable to HTMA design.

Since series Q is mainly associated to special applications, the requested seal type must be specified when an order is placed (pag 6, point 6th).

CARATTERISTICHE PRINCIPALI

Gli innesti a facce piane serie Q sono un prodotto innovativo e originale che trova applicazione ideale in ambienti mediamente corrosivi. La serie Q è una versione speciale derivata dalla serie F in cui i componenti in acciaio al carbonio vengono sottoposti a specifici trattamenti di carbonitrurazione (QPQ). Nei casi in cui i materiali e i trattamenti tradizionali non garantiscano una sufficiente resistenza e non sia necessario o conveniente utilizzare acciai inossidabili, la serie Q permette di ottimizzare il rapporto prestazione/prezzo. La serie Q unisce a queste caratteristiche tutti i vantaggi degli innesti a facce piane. Es. di applicazione: insetticidi, olii diatermici, fluidi di raffreddamento, acqua, etc.

- Materiale: acciaio al carbonio trattato al QPQ;
- Valvole interne in acciaio inossidabile austenitico;
- Molle in AISI 302 e sfere in AISI 420;
- Tenuta totale con innesti separati o accoppiati;
- Perdite di fluido bassissime nelle fasi di accoppiamento e sgancio;
- Nessuna intrusione di agenti esterni durante le connessioni
- Facile pulizia delle superfici di accoppiamento;
- Ghiera con sistema anti-sgancio;
- Aumentata resistenza ad usura, abrasione e corrosione;
- Misura 3/8" (DN 9) intercambiabile a norme HTMA.

Poichè questa serie è destinata ad applicazioni speciali, è opportuno specificare in fase di ordine il tipo di guarnizione (pag. 6 punto 6).

PRESSURE DROP GRAPH

GRAFICO PERDITE DI CARICO

PRESSURE DROP GRAPH GRAFICO PERDITE DI CARICO

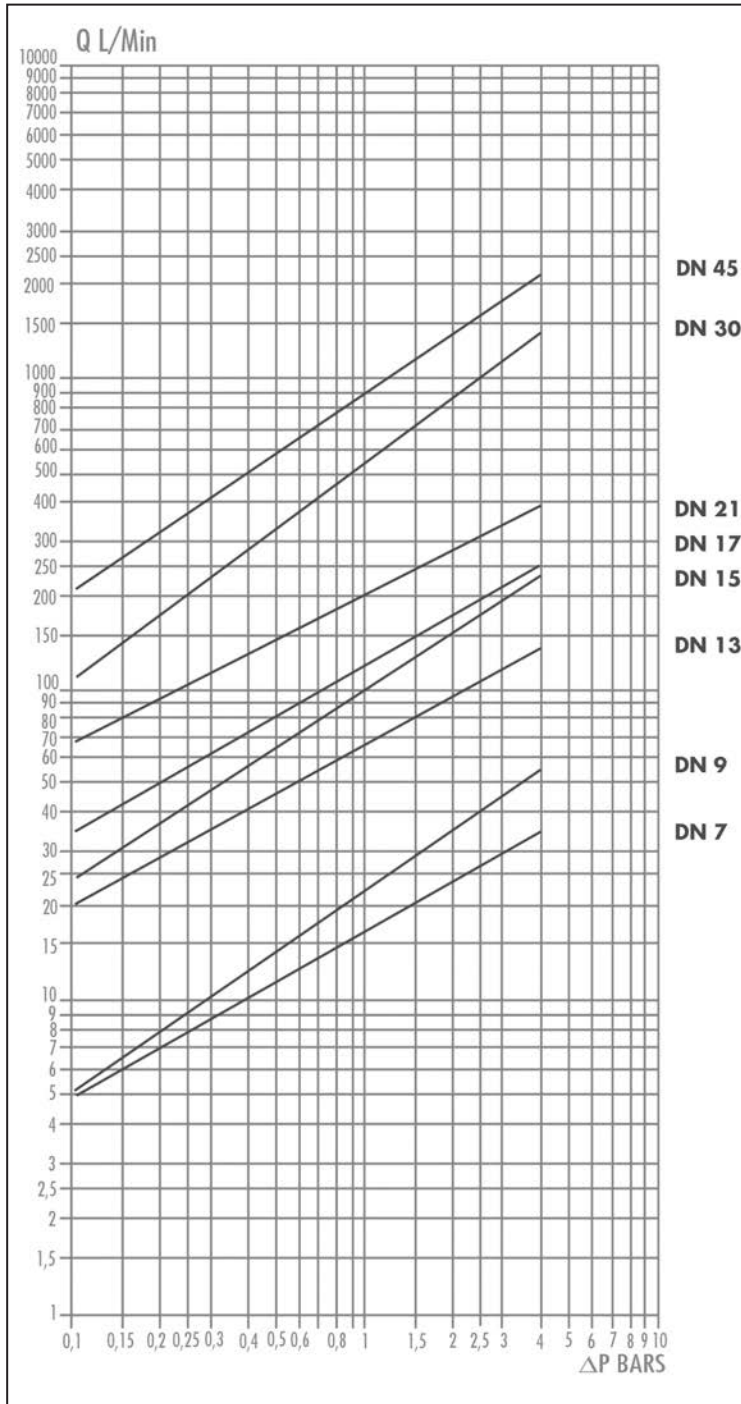

FLUID: HYDRAULIC OIL SAE 10W FLUIDO: OLIO IDRAULICO SAE 10W
TEMPERATURE: 50° C TEMPERATURA: 50° C
VISCOSITY: 3 E° VISCOSITÀ: 3 E°

PERFORMANCES PRESTAZIONI

SIZE BASE	Ø DN mm	MAX WORK PRESSURE MAX PRESS. D'ESERCIZIO		MIN. BURST PRESSURE MIN. PRESSIONE SCOPPIO						WEIGHT PESO				FORCE CONNECTION FORZA D'AGGANCIO	
		bar	psi	coupled accoppiato		plug maschio		socket femmina		plug maschio		socket femmina		kg	lbs
				bar	psi	bar	psi	bar	psi	kg	lbs	kg	lbs		
04	7	300	4350	1200	17400	1600	23200	500	7250	0.045	0.100	0.080	0.180	18	40.00
06	9	300	4350	1200	17400	1650	23925	750	10875	0.055	0.122	0.150	0.330	18	40.00
06	9	300	4350	1200	17400	1650	23925	750	10875	0.090	0.200	0.270	0.600	18	40.00
08	13	250	3625	1200	17400	1600	23200	600	8700	0.090	0.200	0.270	0.600	18	40.00
08	13	250	3625	1200	17400	1600	23200	600	8700	0.185	0.410	0.465	1.030	18	40.00
12	15	250	3625	1000	14500	1400	20300	550	7975	0.185	0.410	0.465	1.030	20	44.44
16	17	250	3625	850	12325	1100	15950	450	6525	0.270	0.600	0.720	1.600	25	55.56
20	21	250	3625	850	12325	1100	15950	600	8700	0.600	1.330	1.250	2.780	31	68.89
24	30	200	2900	700	10150	850	12325	400	5800	0.900	2.000	2.100	4.670	43	95.56
32	45	180	2610	700	10150	700	10150	400	5800	1.450	3.220	4.150	9.220	50	111.11

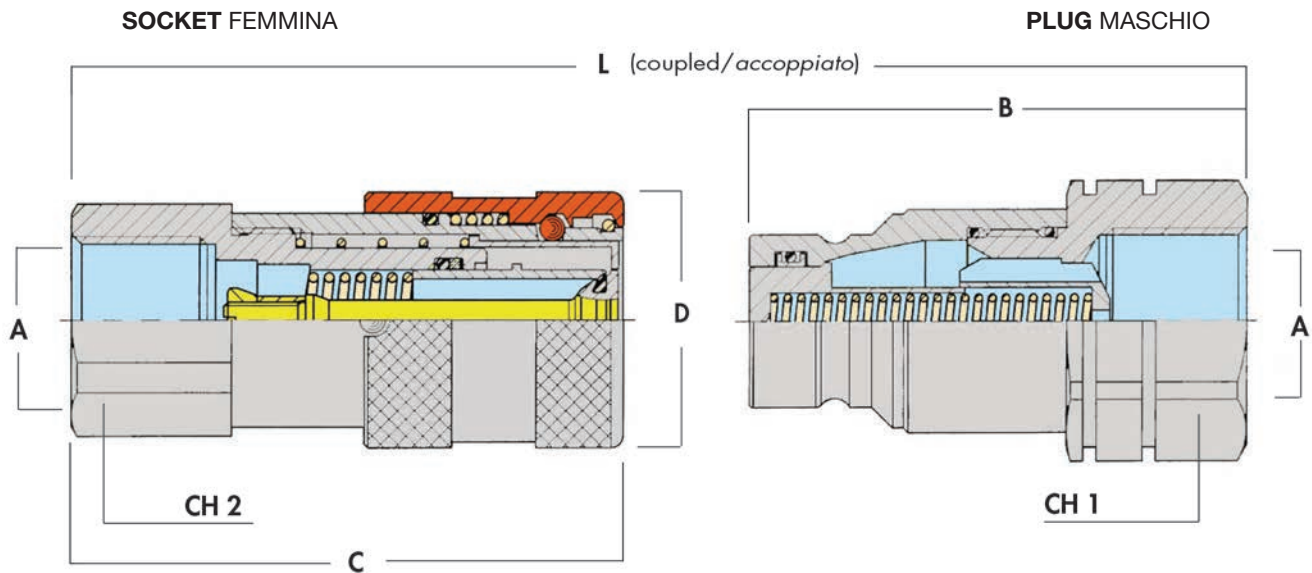

SIZE BASE	Ø DN mm	CODE CODICE		Ø A*	B		C		Ø D		L		CH 1		CH 2	
		plug maschio	socket femmina		mm	in	mm	in	mm	in	mm	in	mm	in	mm	in
04	7	MM10-04	MF10-04	1/4" BSP	48	1.89	48	1.89	28	1.10	85.5	3.37	22	0.87	22	0.87
		MM15-04	MF15-04	1/4" NPTF												
		MM18-04	MF18-04	1/4" NPTF												
06	9	MM10-06	MF10-06	3/8" BSP	60	2.36	64.5	2.54	32	1.26	109	4.29	24	0.94	27	1.06
		MM15-06	MF15-06	3/8" NPTF												
		MM18-06	MF18-06	3/8" BSPT												
06	9	MM10-08	MF10-08	1/2" BSP	62.5	2.46	69.5	2.74	32	1.26	117	4.59	27	1.06	27	1.06
		MM15-08	MF15-08	1/2" NPTF												
		MM18-08	MF18-08	1/2" BSPT												
08	13	MM20-08	MF20-08	1/2" BSP	68	2.68	73.5	2.89	38	1.50	125	4.92	32	1.26	32	1.26
		MM25-08	MF25-08	1/2" NPTF												
		MM28-08	MF28-08	1/2" BSPT												
08	13	MM10-12	MF10-12	3/4" BSP	70.5	2.78	80.5	3.17	38	1.50	135	5.30	36	1.42	36	1.42
		MM15-12	MF15-12	3/4" NPTF												
		MM18-12	MF18-12	3/4" BSPT												
12	15	MM20-12	MF20-12	3/4" BSP	70.5	2.78	78	3.07	42	1.65	132	5.20	36	1.42	36	1.42
		MM25-12	MF25-12	3/4" NPTF												
		MM28-12	MF28-12	3/4" NPTF												
16	17	MM10-16	MF10-16	1" BSP	82.5	3.25	92.5	3.64	48	1.89	154	6.06	45	1.77	45	1.77
		MM15-16	MF15-16	1" NPTF												
		MM18-16	MF18-16	1" BSPT												
20	21	MM10-20	MF10-20	1.1/4" BSP	90	3.54	105	4.13	55	2.17	173	6.81	55	2.17	55	2.17
		MM15-20	MF15-20	1.1/4" NPTF												
		MM18-20	MF18-20	1.1/4" NPTF												
24	30	MM10-24	MF10-24	1.1/2" BSP	111	4.37	133	5.22	80	3.15	215	8.46	70	2.76	65	2.56
		MM15-24	MF15-24	1.1/2" NPTF												
		MM18-24	MF18-24	1.1/2" BSPT												

* Other threads available on request Ulteriori filettature disponibili a richiesta.

MAIN DATA

Series M flat face couplings are made in AISI 316 stainless steel and represent the ideal solution for corrosive environmental situations or for industrial applications with special chemical fluids, food and pharmaceutical.

- Material: AISI 316 stainless steel;
- Springs in AISI 302, balls in AISI 316;
- Perfect sealing of plug and socket both when coupled and uncoupled;
- Extremely low spillage during connection and disconnection.
- No inclusion of air external media during connection and disconnection;
- The flat faces are easy to clean;
- Sleeve with a safety device preventing from accidental disconnection;

Since series M is mainly associated to special applications, the requested seal type must be specified when an order is placed (see pag 6, point 6th).

CARATTERISTICHE PRINCIPALI

Gli innesti a facce piane serie M sono costruiti in acciaio inossidabile e rappresentano la soluzione ideale per ambienti altamente corrosivi o applicazioni industriali con fluidi chimici, alimentari e farmaceutici.

- Materiale: acciaio inox AISI 316;
- Molle in AISI 302 e sfere in AISI 316;
- Alte pressioni di esercizio;
- Tenuta totale con innesti separati o accoppiati;
- Perdite di fluido bassissime nelle fasi di accoppiamento e sgancio;
- Nessuna intrusione di agenti esterni durante le connessioni;
- Facile pulizia delle superfici di accoppiamento;
- Ghiera con sistema anti-sgancio;
- Misura 3/8" (DN 9) intercambiabile a norme HTMA.

Poichè questa serie è destinata ad applicazioni speciali è opportuno specificare in fase di ordine la guarnizione (pag. 6 punto 6).

PRESSURE DROP GRAPH GRAFICO PERDITE DI CARICO

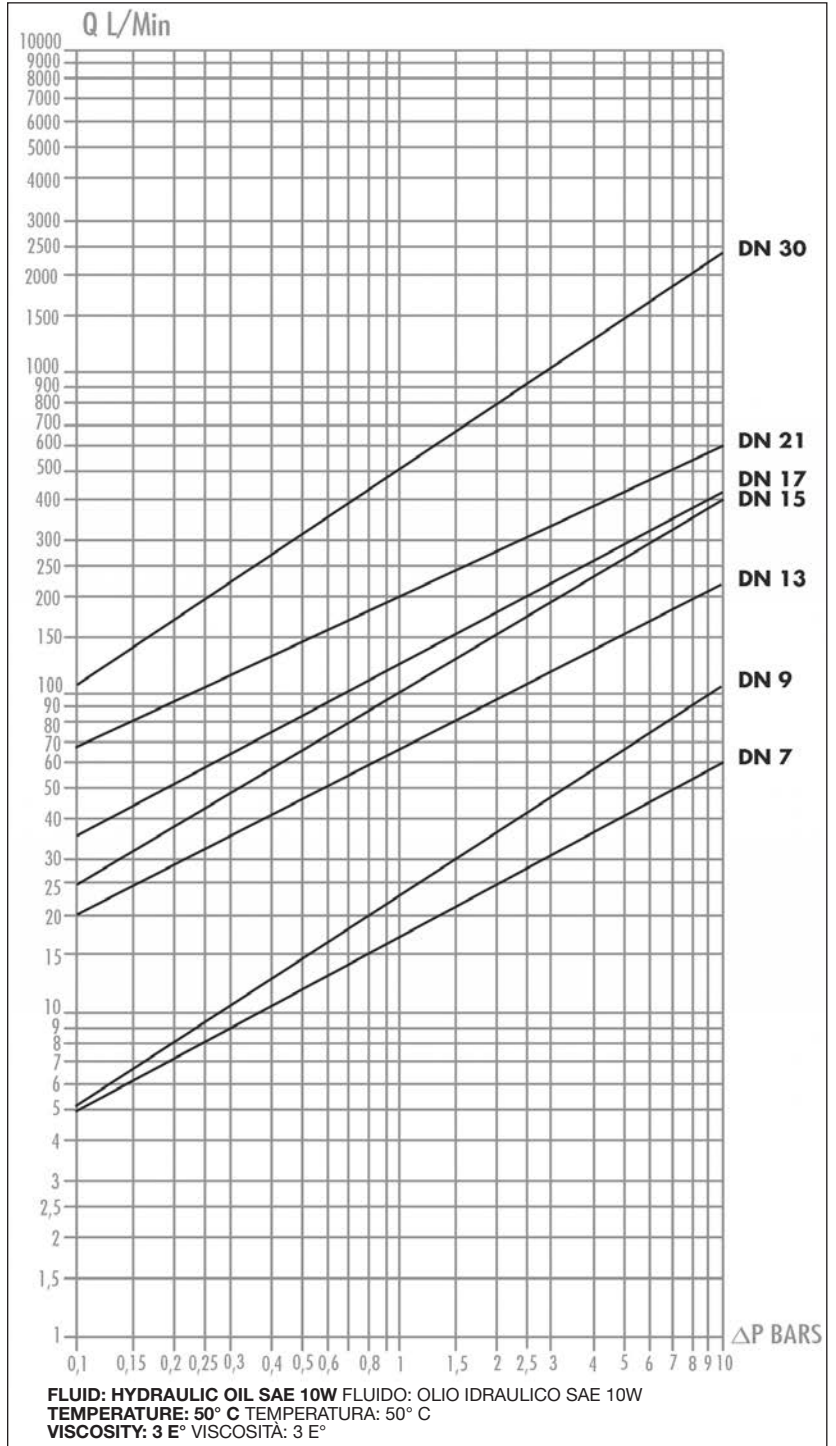

PERFORMANCES PRESTAZIONI

SIZE BASE	Ø DN	MAX WORK PRESSURE MAX PRESS. D'ESERCIZIO		MIN. BURST PRESSURE MIN. PRESSIONE SCOPPIO						WEIGHT PESO				FORCE CONNECTION FORZA D'AGGANCIAMENTO	
		bar	psi	coupled accoppiato		plug maschio		socket femmina		plug maschio		socket femmina		kg	lbs
				bar	psi	bar	psi	bar	psi	kg	lbs	kg	lbs		
04	7	350	5075	1700	24650	1450	21025	600	8700	0.060	0.130	0.080	0.180	18	40.00
06	9	350	5075	1500	21750	1500	21750	800	11600	0.148	0.320	0.150	0.330	18	40.00
06	9	350	5075	1500	21750	1500	21750	800	11600	0.148	0.320	0.270	0.600	18	40.00
08	13	350	5075	1450	21025	1000	14500	750	10875	0.273	0.600	0.270	0.600	18	40.00
08	13	350	5075	1450	21025	1000	14500	750	10875	0.268	0.590	0.465	1.030	18	40.00
12	15	350	5075	1250	18125	950	13775	500	7250	0.300	0.660	0.465	1.030	20	44.44
16	17	350	5075	1150	16675	800	11600	600	8700	0.409	0.900	0.720	1.600	25	55.56
20	21	300	4350	850	12325	800	11600	500	7250	0.610	1.350	1.250	2.780	31	68.89
24	30	250	3625	700	10150	700	10150	400	5800	1.630	3.620	2.100	4.670	43	95.56

SJ 10 series

STRAIGHT SWIVEL JOINTS
GIUNTI GIREVOLI IN LINEA

$1/2'' \leq$

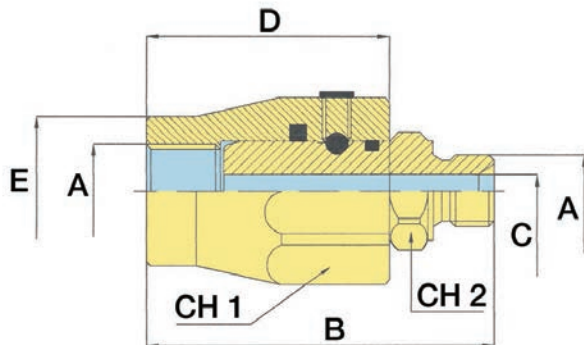

$\geq 3/4''$

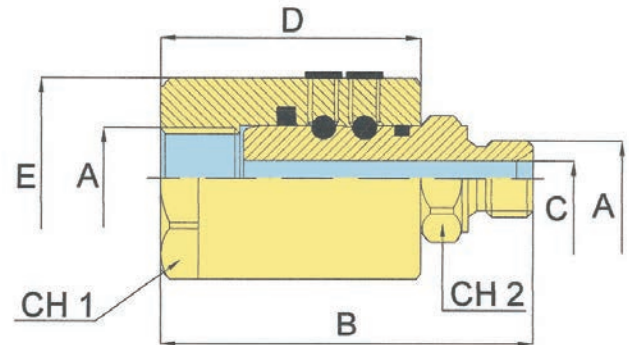

CODE CODICE	Ø A*	B		C		D		Ø E		CH 1		CH 2		MAX PRESSURE IN ROTATION MAX PRESSIONE IN ROTAZIONE		STATIC MAX PRESSURE MAX PRESSIONE STATICA	
		mm	in	mm	in	mm	in	mm	in	mm	in	mm	in	bar	psi	bar	psi
SJ10-04	1/4"	61	2.40	6	0.24	42	1.65	24	0.94	ES30	1.18	ES19	0.75	200	2900	400	5800
SJ10-06	3/8"	66	2.60	8.5	0.33	44	1.73	25	0.98	ES34	1.34	ES24	0.94	200	2900	400	5800
SJ10-08	1/2"	71	2.80	11.5	0.45	47	1.85	32	1.26	ES36	1.42	ES27	1.06	150	2175	300	4350
SJ10-12	3/4"	89	3.50	15	0.59	60	2.36	49.5	1.95	ES45	1.77	CH34	1.34	150	2175	300	4350
SJ10-16	1"	98	3.86	20	0.79	65	2.56	54.5	2.15	ES50	1.97	CH41	1.61	100	1450	300	4350
SJ10-20	1.1/4"	101	3.98	28	1.10	63	2.48	60	2.36	ES55	2.17	CH50	1.97	100	1450	300	4350
SJ10-24	1.1/2"	110	4.33	35	1.38	70	2.76	69.5	2.74	ES65	2.56	CH55	2.17	80	1160	300	4350
SJ10-32	2"	119	4.69	44	1.73	75	2.95	84.5	3.33	ES75	2.95	CH65	2.56	50	725	250	3625

* Other threads available on request Ulteriori filettature disponibili a richiesta.

MAIN DATA:

The series SJ 10 swivel joints are designed to be mounted between a hose assembly and a rigid component in order to allow and compensate occasional rotations, preventing hose damages. The swivel joint rotation is based on one or two rows of radial balls (one row up to size 1/2" included).

- Standard seals in nitril rubber;
- Working temperatures with standard seals: -20°C / +110°C;
- Standard thread: BSP (GAS);
- Special materials on request: AISI 303, AISI 316, Brass;
- Special seals on request: Viton, EPDM, Silicone;
- Special thread on request: NPTF, Metric, UNF;

IMPORTANT:

SJ 10 series is not suitable for continuous or fast rotation.

CARATTERISTICHE PRINCIPALI:

I giunti girevoli in linea serie SJ 10 trovano applicazione tra un tubo flessibile e una parte rigida per compensare torsioni e rotazioni occasionali. Il movimento del giunto sul proprio asse impedisce che il tubo si danneggi. La rotazione del giunto è imperniata su una o due corone di sfere radiali (una fino a 1/2" compreso).

- Guarnizioni standard in gomma nitrilica;
- Temperature d'esercizio con guarnizioni standard: -20°C / +110°C;
- Filettature standard: BSP (GAS);
- Materiali speciali a richiesta: AISI 303, AISI 316, Ottone;
- Guarnizioni speciali a richiesta: Viton, EPDM, Silicone;
- Filettature speciali a richiesta: NPTF, Metrica, UNF;

ATTENZIONE:

I giunti SJ 10 non sono idonei per rotazioni veloci e continuative.

SJ 90 series

90° SWIVEL JOINTS
GIUNTI GIREVOLI A 90°

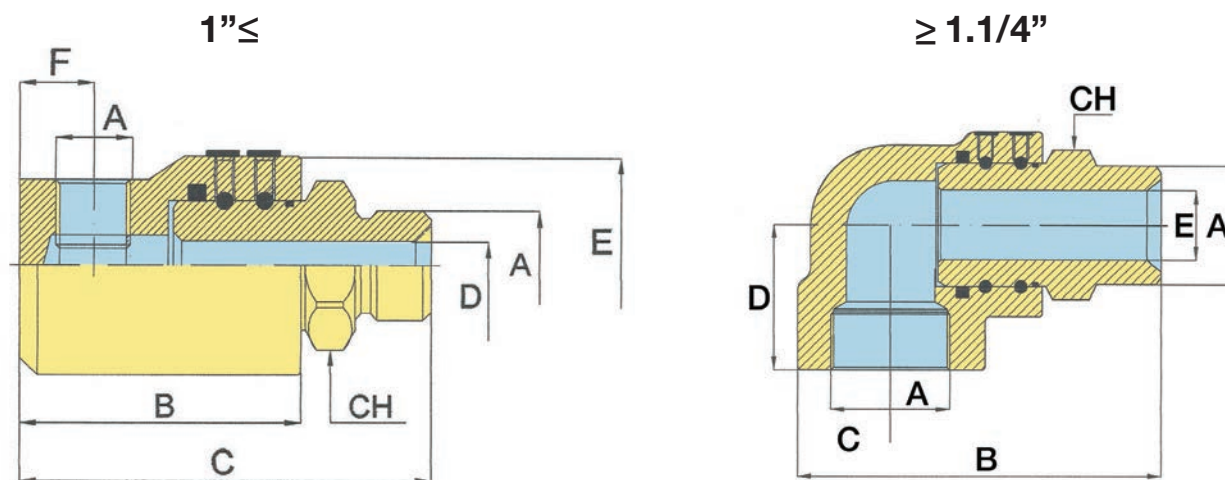

CODE CODICE	Ø A*	B		C		D		Ø E		F		CH		MAX PRESSURE IN ROTATION MAX PRESSIONE IN ROTAZIONE		STATIC MAX PRESSURE MAX PRESSIONE STATICA	
		mm	in	mm	in	mm	in	mm	in	mm	in	mm	in	bar	psi	bar	psi
SJ90-04	1/4"	50	1.97	69	2.72	6	0.24	33.5	1.32	11	0.43	ES19	0.75	200	2900	400	5800
SJ90-06	3/8"	54	2.13	76	2.99	8.5	0.33	37.5	1.48	13	0.51	ES24	0.94	200	2900	400	5800
SJ90-08	1/2"	63	2.48	87	3.43	11.5	0.45	39.5	1.56	14	0.55	ES27	1.06	150	2175	300	4350
SJ90-12	3/4"	74	2.91	104	4.09	15	0.59	54.5	2.15	19.5	0.77	ES34	1.34	150	2175	300	4350
SJ90-16	1"	87	3.43	119	4.69	20	0.79	55/60	2.17/2.36	24	0.94	ES41	1.61	100	1450	300	4350
SJ90-20	1.1/4"	119.5	4.70	32	1.26	52	2.05	28	1.10	-	-	50	1.97	100	1450	300	4350
SJ90-24	1.1/2"	140	5.51	37	1.46	62	2.44	35	1.38	-	-	55	2.17	80	1160	300	4350
SJ90-32	2"	151	5.94	42	1.65	64	2.52	44	1.73	-	-	65	2.56	50	725	250	3625

* Other threads available on request Ulteriori filettature disponibili a richiesta.

MAIN DATA:

The series SJ 90 swivel joints are designed to be mounted between a hose assembly and a rigid component in order to allow and compensate occasional rotations, preventing hose damages. The swivel joint rotation is based on one or two rows of radial balls (one row up to size 1/2" included).

- Standard seal in nitril rubber;
- Working temperatures with standard seals: -20°C / +110°C;
- Standard thread: BSP (GAS);
- Special material on request: AISI 303, AISI 316, Brass;
- Special seals on request: Viton, EPDM, Silicone;
- Special thread on request: NPTF, Metric, UNF;

IMPORTANT:

SJ 90 series is not suitable for continuous or fast rotation.

CARATTERISTICHE PRINCIPALI:

I giunti girevoli in linea serie SJ 90 trovano applicazione tra un tubo flessibile e una parte rigida per compensare torsioni e rotazioni occasionali. Il movimento del giunto sul proprio asse impedisce che il tubo si danneggi. La rotazione del giunto è impernata su una o due corone di sfere radiali (una fino a 1/2" compreso).

- Guarnizioni standard in gomma nitrilica;
- Temperature d'esercizio con guarnizioni standard: -20°C / +110°C;
- Filettature standard: BSP (GAS);
- Materiali speciali a richiesta: AISI 303, AISI 316, Ottone;
- Guarnizioni speciali a richiesta: Viton, EPDM, Silicone;
- Filettature speciali a richiesta: NPTF, Metrica, UNF;

ATTENZIONE:

I giunti SJ 90 non sono idonei per rotazioni veloci e continuative.

CV series

IN LINE CHECK VALVE
VALVOLA DI NON RITORNO

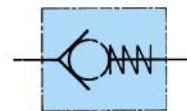
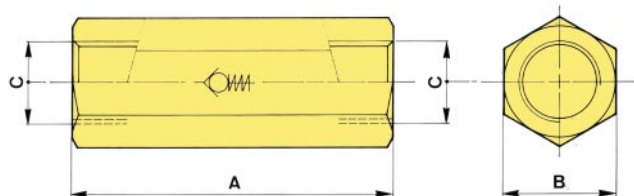

CODE CODICE	Ø C*	MAX FLOW MAX FLUSSO	MAX PRESSURE MAX PRESSIONE		A		B	
			l/min	bar	psi	mm	in	mm
CV-04	1/4"	13	350	5000	60	2.36	19	0.75
CV-06	3/8"	25	350	5000	70	2.76	24	0.94
CV-08	1/2"	40	350	5000	76	2.99	30	1.18
CV-12	3/4"	60	300	4300	92	3.62	36	1.42
CV-16	1"	90	250	3600	108	4.25	45	1.77
CV-20	1.1/4"	160	250	3600	127	5.00	55	2.17
CV-24	1.1/2"	210	250	3600	142	5.59	65	2.56

VPCC series

BURST HOSE VALVE
VALVOLA DI SICUREZZA PER TUBAZIONI

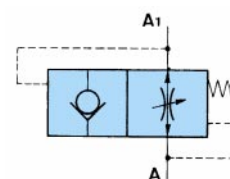
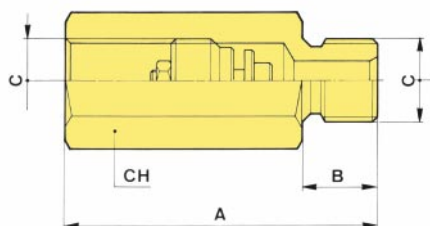

CODE CODICE	Ø C*	B		CH		A	
		mm	in	mm	in	mm	in
VPCC-04	1/4"	13	0.51	19	0.75	53	2.09
VPCC-06	3/8"	13	0.51	22	0.87	55	2.17
VPCC-08	1/2"	14	0.55	27	1.06	64	2.52
VPCC-12	3/4"	15	0.59	36	1.42	67	2.64

* Standard thread is BSP (GAS). Available thread on request: metric, NPTF, SAE and UNF.
Filettature standard BSP (GAS). Disponibili a richiesta filettature metriche, NPTF, SAE e UNF

CVP series

BURST HOSE CARTRIDGE VALVE
VALVOLA DI SICUREZZA A CARTUCCIA

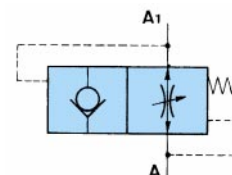
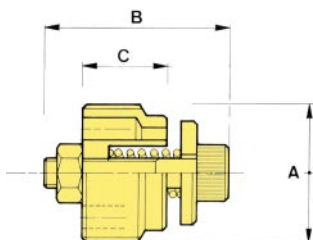

CODE CODICE	Ø A*	B		C	
		mm	in	mm	in
CVP-04	1/4"	19	0.75	8	0.31
CVP-06	3/8"	23	0.91	10.5	0.41
CVP-08	1/2"	29	1.14	13	0.51
CVP-12	3/4"	34	1.34	18	0.71

DPC series

DOUBLE PILOT OPERATED CHECK VALVE
VALVOLA DI BLOCCO DOPPIO PILOTA

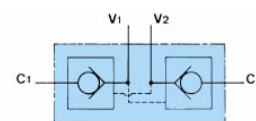
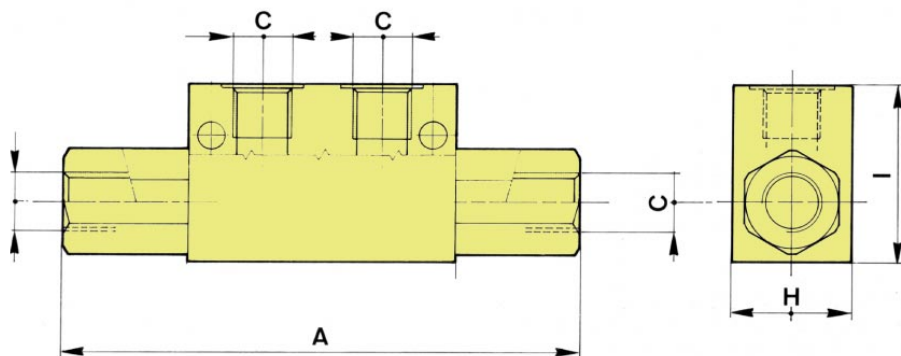

CODE CODICE	Ø C*	MAX FLOW MAX FLUSSO	MAX PRESSURE MAX PRESSIONE		A		I		H	
		l/min	bar	psi	mm	in	mm	in	mm	in
DPC-04	1/4"	12	350	5000	126	4.96	45	1.77	30	1.18
DPCX-06	3/8"	20	350	5000	126	4.96	45	1.77	30	1.18
DPC-06	3/8"	30	350	5000	158	6.22	60	2.36	40	1.57
DPC-08	1/2"	45	350	5000	174	6.85	60	2.36	40	1.57
DPC-12	3/4"	85	300	4350	212	8.35	70	2.76	50	1.97

* Standard thread is BSP (GAS). Available thread on request: metric, NPTF, SAE and UNF.
Filettature standard BSP (GAS). Disponibili a richiesta filettature metriche, NPTF, SAE e UNF

VSU series

TROTTLER VALVE
VALVOLA DI STROZZAMENTO

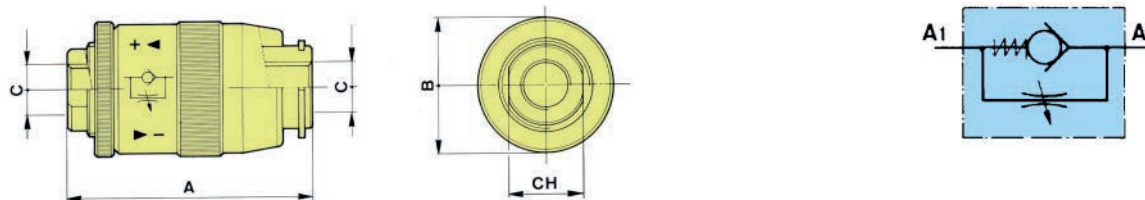

CODE CODICE	Ø C*	MAX FLOW MAX FLUSSO		MAX PRESSURE MAX PRESSIONE		A		B		CH	
		l/min	bar	psi	mm	in	mm	in	mm	in	
VSU-04	1/4"	12	350	5000	62	2.44	34	1.34	19	0.75	
VSU-06	3/8"	30	350	5000	72	2.83	40	1.57	24	0.94	
VSU-08	1/2"	45	350	5000	80	3.15	46	1.81	30	1.18	
VSU-12	3/4"	85	300	4350	100	3.94	54	2.13	36	1.42	
VSU-16	1"	100	300	4350	115	4.53	66	2.60	41	1.61	
VSU-20	1.1/4"	150	250	3600	135	5.31	82	3.23	55	2.17	
VSU-24	1.1/2"	220	250	3600	150	5.91	93	3.66	60	2.36	

VRX series

UNI-DIRECTIONAL FLOW REGULATOR
REGOLATORE DI FLUSSO UNIDIREZIONALE

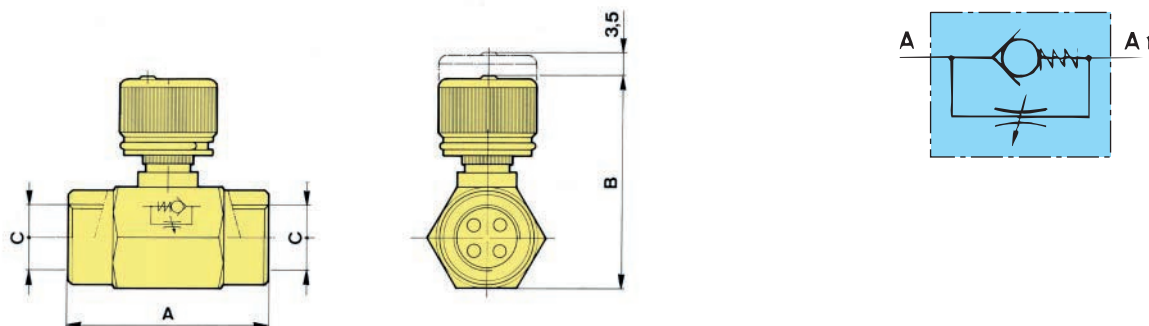

CODE CODICE	Ø C*	MAX FLOW MAX FLUSSO		MAX PRESSURE MAX PRESSIONE		A		B	
		l/min	bar	psi	mm	in	mm	in	
VRX-04	1/4"	12	300	4350	54	2.13	64	2.52	
VRX-06	3/8"	25	300	4350	62	2.44	64	2.52	
VRX-08	1/2"	40	280	4000	62	2.44	64	2.52	

* Standard thread is BSP (GAS). Available thread on request: metric, NPTF, SAE and UNF.
Filettature standard BSP (GAS). Disponibili a richiesta filettature metriche, NPTF, SAE e UNF

VRU series

UNI-DIRECTIONAL FLOW REGULATOR
REGOLATORE DI FLUSSO UNIDIREZIONALE

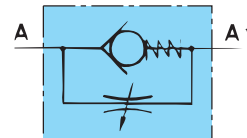
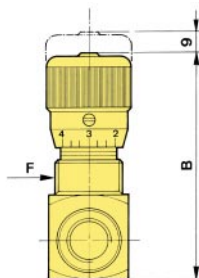
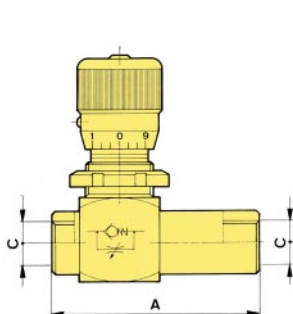

CODE CODICE	Ø C*	MAX FLOW MAX FLUSSO	MAX PRESSURE MAX PRESSIONE		A		B		F
		l/min	bar	psi	mm	in	mm	in	
VRU-04	1/4"	12	350	5000	72	2.83	80	3.15	M20 X 1
VRU-06	3/8"	30	350	5000	78	3.07	85	3.35	M25 X 1.5
VRU-08	1/2"	45	350	5000	92	3.62	92	3.62	M30 X 1.5
VRU-12	3/4"	85	300	4350	106	4.17	105	4.13	M35 X 1.5

VRB series

BI-DIRECTIONAL FLOW REGULATOR
REGOLATORE DI FLUSSO BIDIREZIONALE

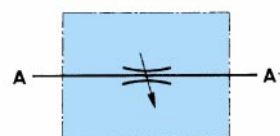
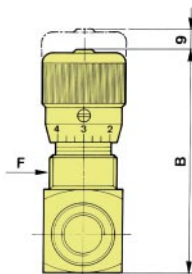
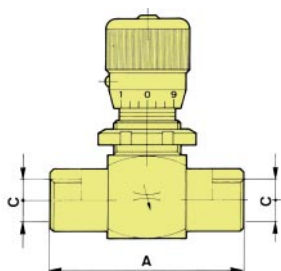

CODE CODICE	Ø C*	MAX FLOW MAX FLUSSO	MAX PRESSURE MAX PRESSIONE		A		B		F
		l/min	bar	psi	mm	in	mm	in	
VRB-04	1/4"	12	350	5000	45	1.77	80	3.15	M20 X 1
VRB-06	3/8"	30	350	5000	52	2.05	85	3.35	M25 X 1.5
VRB-08	1/2"	45	350	5000	60	2.36	92	3.62	M30 X 1.5
VRB-12	3/4"	85	300	4350	68	2.68	105	4.13	M35 X 1.5

* Standard thread is BSP (GAS). Available thread on request: metric, NPTF, SAE and UNF.
Filettature standard BSP (GAS). Disponibili a richiesta filettature metriche, NPTF, SAE e UNF



intertraco

Intertraco (Italia) S.p.A.

Via E. Amaldi, 1/A
I-46029 SUZZARA (MN)-ITALY
P.O. Box N°7/C
Tel. +39 0376 539 711
Fax +39 0376 521 722
e-mail info@intertraco.it

www.intertraco.it